

# RADIO ASTRONOMY

**Journal of the Society of Amateur Radio Astronomers  
July- August 2013**





Bill Lord  
SARA President

Melinda Lord  
Editor

Whitham D. Reeve  
Contributing Editor

Christian Monstein  
Contributing Editor

Stan Nelson  
Contributing Editor

Radio Astronomy is published bimonthly as the official journal of the Society of Amateur Radio Astronomers. Duplication of uncopyrighted material for educational purposes is permitted but credit shall be given to SARA and to the specific author. Copyrighted materials may not be copied without written permission from the copyright owner.

Radio Astronomy is available for download only by SARA members from the SARA web site and may not be posted anywhere else.

It is the mission of the Society of Amateur Radio Astronomers (SARA) to: Facilitate the flow of information pertinent to the field of Radio Astronomy among our members; Promote members to mentor newcomers to our hobby and share the excitement of radio astronomy with other interested persons and organizations; Promote individual and multi station observing programs; Encourage programs that enhance the technical abilities of our members to monitor cosmic radio signals, as well as to share and analyze such signals; Encourage educational programs within SARA and educational outreach initiatives. Founded in 1981, the Society of Amateur Radio Astronomers, Inc. is a membership supported, non-profit [501(c) (3)], educational and scientific corporation.

Copyright © 2013 by the Society of Amateur Radio Astronomers, Inc. All rights reserved

**On the Cover-** The GBT at the National Radio Astronomy Observatory in Green Bank, WV the morning of July 17<sup>th</sup>. Photo courtesy David Thomas

## Radio Waves

President's Page	3
Editors' Notes	4

## News

Report from SARA Annual Conference in Green Bank- Stan Nelson	5
SARA Annual Conference – Results of voting for SARA Officers	9
SARA Western Conference Information	10
SARA Western Conference- Call for Papers	12
Mark Your Calendar	12
Ruby Payne-Scott, the First Female Radio Astronomer- Jeff Lichtman	13
News from Around the Web	15

## Feature Articles

Preamplifiers for Callisto Solar Radio Spectrometer Whitham D. Reeve and Christian Montsein	17
High-energySpy- Dr. Martin C. Weisskopf	36
Low Cost Hydrogen Line Radio Telescope for £160 using the RTL SDR Peter East	38
The Horn Antenna in Radio Astronomy- Jeff Lichtman	47
High Noise Levels — Possible Solutions- Richard Flagg	52
SID Monitoring in Slovakia- Ivan Dorotovic	53
Spectrum Ecology & Conservation- Charles Osborne	58
Applying and Measuring Ferrite Beads- Whitham D. Reeve and Tom Hagen	61
Book Review "Radio Nature" - Whit Reeve	71
Book Review "Cosmic Noise by Sullivan" - Dave James	75
Great Projects to Get Started in Radio Astronomy	78

## Membership

New Members	79
Membership Dues & Promotion	79

## Administrative

Officers, directors and additional SARA contacts	81
--	----

## Resources

Mark Your Calendar	
New Web Links	82
Online Resources	83
For Sale, Trade and Wanted	84

### President's Page

The recent Annual SARA Conference held at the National Radio Astronomy Observatory in Green Bank, West Virginia was a great success thanks to the many members that gave presentations and assisted with planning. I want to thank Tom Crowley for his work in getting top notch speakers, making arrangements with NRAO and putting together the Proceedings. His wife Lynn Crowley deserves special thanks for keeping the spouses entertained on day trips that I hear were quite enjoyable.

As always, SueAnn Heatherly and the NRAO staff welcomed us and made our stay enjoyable. A recap of the conference by Stan Nelson can be found on page 5 of this issue. Photos of the conference can be viewed at <http://www.flickr.com/photos/tnskynet/sets/72157634739151176/>. Thanks to Charles Osborne, Carl Lyster and David Thomas for sending pictures in addition to what we took.

Dates have been set for the 2014 Western Regional Conference to be held at Owens Valley Radio Observatory near Bishop, California March 22 and 23. More information is in this Journal as well as on-line at <http://www.radio-astronomy.org/meetings>.

The Annual Conference is set for June 29 to July 2, 2014 at the National Radio Astronomy Observatory in Green Bank, West Virginia. The Radio Jove team will be holding a conference following us on July 2 to July 4. SARA members are invited to attend along with Radio Jove enthusiasts. More details will be made available on-line at <http://www.radio-astronomy.org/meetings> and in upcoming Journals.

The editorial staff of the Journal is working very hard to publish a quality publication for our members. They welcome articles about observations, member projects, designing equipment, software used for observing, book reviews and analysing data. Please think about taking some time to write and tell us about what you are doing. This will enhance the Journal for all of our readers.

Until next time, happy monitoring,  
Bill Lord  
KJ4SKL



## Editor's Notes

We are always looking for basic radio astronomy articles, radio astronomy tutorials, theoretical articles, application and construction articles, news pertinent to radio astronomy, profiles and interviews with amateur and professional radio astronomers, book reviews, puzzles (including word challenges, riddles, and crossword puzzles), anecdotes, expository on "bad astronomy," articles on radio astronomy observations, suggestions for reprint of articles from past journals, book reviews and other publications, and announcements of radio astronomy star parties, meetings, and outreach activities.

If you would like to write an article for *Radio Astronomy*, please follow the Author's Guide on the SARA web site: [http://www.radio-astronomy.org/publicat/RA-JSARA\\_Author's\\_Guide.pdf](http://www.radio-astronomy.org/publicat/RA-JSARA_Author's_Guide.pdf). Please note that the new version of the Author's Guide includes several changes, mostly dealing with article images.

Let us know if you have questions; we are glad to assist authors with their articles and papers and will not hesitate to work with you. You may contact your editors any time via email here: [editor@radio-astronomy.org](mailto:editor@radio-astronomy.org).

Please consider submitting your radio astronomy observations for publication: any object, any wavelength. Strip charts, spectrograms, magnetograms, meteor scatter records, space radar records, photographs; examples of radio frequency interference (RFI) are also welcome.

*Guidelines for submitting observations may be found here:* [http://www.radio-astronomy.org/publicat/RA-JSARA\\_Observation\\_Submission\\_Guide.pdf](http://www.radio-astronomy.org/publicat/RA-JSARA_Observation_Submission_Guide.pdf)

### Tentative *Radio Astronomy* due dates and distribution schedule

Issue	Articles	Radio Waves	Review	Distribution
Jan – Feb	February 12	February 20	February 23	February 28
Mar – Apr	April 12	April 23	April 25	April 30
May – Jun	June 12	June 23	June 25	June 30
Jul – Aug	August 12	August 23	August 25	August 31
Sep – Oct	October 12	October 23	October 25	October 31
Nov – Dec	December 12	December 15	December 20	December 31

### **HELP WANTED**

Want to see all the great Journal articles before anyone else?

We are looking for an editor(s) for the SARA Journal. We have three very active contributing editors who write papers for the Journal and need someone who will combine all of the submittals. You do not have to be a radio astronomy expert. We have members willing to review technical articles submitted for publication.

If you are interested in the position, please contact Bill Lord [president@radio-astronomy.org](mailto:president@radio-astronomy.org) or call 319-591-1131.

## News

### S.A.R.A. Annual Conference at Green Bank Radio Observatory

By Stan Nelson

Bill Lord, President of S.A.R.A. asked me to write about the experience of attending an annual conference. I share my viewpoint for those who may be planning their first trip. If you haven't attended a S.A.R.A conference, I highly recommend travelling to Green Bank. Here, you get to meet professionals and amateurs as they share their enthusiasm and knowledge of radio astronomy. This year was my first trip to Green Bank. I had attended the Western Conference in Socorro, New Mexico last February where I had a chance to meet with numerous members that also attended this year's annual conference. There, I decided to make the effort to go to the 'Mecca' of radio astronomy, Green Bank, West Virginia.

The trip to Green Bank was an interesting challenge. Be prepared for some mountain driving on real curves. It took me nearly four hours to drive from Charlottesville, Virginia. I depended on my iPhone GPS and found a couple of problems with its guidance. Cell phone coverage gets sporadic as you get closer. And there is NO cell phone coverage at the Green Bank facility. You will have to shut off all RF generating devices such as cell phones, iPads, etc. I expected lots of great scenery but alas there seemed to be only trees, trees, and more trees. The most welcomed sight was the feed structure of the GBT, sticking above the trees when I arrived near dark. And the sign shown below.



The lodging is near the entrance. Once checked in, there is Internet connections in the rooms that worked very well and I was able to Skype out as a substitute for cell phone calls. Also, I recommend you dig out that old 35mm film camera and bring a couple of rolls a film if you're going to do the GBT tour. Digital cameras are forbidden near the dish since they do generate some radio frequency interference (RFI). You can buy a cheap throw-a-way camera in the gift shop.

The sessions take place on Monday and Tuesday in the main center, a short walk from the lodging. You pass the re-built Reber radio telescope. The group pictures were taken in front of it.

The sessions cover a wide range of radio astronomy topics. You are given a copy of the Conference Proceedings when you check in. Copies of the proceedings can be purchased from SARA at <http://www.radio-astronomy.org/2013-conference-proceedings>.

All of the talks were interesting. I found several especially interesting, related to what I am currently working with. That's the fun of the conference. The highlight was the keynote speaker, Dan Reichart, who gave us a tour of remote-controlled telescope observatories right there in the conference room via the internet. I also found Chip Sufitchi's talk regarding his use of Arduino Uno programmable devices very helpful. I was vaguely aware of the gadgets but the fact he has integrated them into logging signal levels from SID receiver got me to think it could solve inexpensively some ideas I was working with. One of the nice things about a conference is when the sessions are over and everyone hits the social hour you can ask a lot

of questions of the speaker. That evening I ordered an Arduino Uno R3 board, a GPS shield, and an Ethernet shield for the Arduino. That's the great thing about the conference. Everyone shares their ideas and expertise.

Another eye opening talk came at the end of the conference. Sue Ann Heatherly, NRAO, gave us a demonstration on how to use the 20 foot dish remotely via the internet. She showed us a real-time survey of the Sun. The use of these facilities by amateurs is available to some extent. There is talk of providing dish time for a fee in the future.

On the second day, Tuesday, we broke up into two groups to visit the NRAO labs and the GBT. The labs were full of the usual high tech stuff. Receivers, panels, cryogenics, libraries, and the site control room where astronomers were working on data. Most of the staff astronomers, we were told, were at a conference at the Arecibo dish in Puerto Rico. Then we were bussed down to the GBT.



Before the tour, please wear good covered shoes, no open toes. You don't want to get tangled up in the railings. You will be given hard hats as you leave the bus. Our guide enjoyed sharing the details of the scope. Remember, the scope is big. And you go up two elevators. We were advised keep our eyes on the hard hat in front of us if we felt queasy with heights. There is a short walk from one elevator to the other. On top, you can enter the receiver shed and view the horns and electronics used for the different bands.

Below: Stan leaning on L-Band horn equipment in the GBT.



Below: view of the GBT's elevators and cat walk.



Below is another feature of the conference: Melinda's table of goodies for sale.



At the end of the conference, door prizes galore were raffled off. I think nearly everyone's number was called. The table was almost bare. But, mine was finally called. At the table I scanned the few items left and lo and behold, I picked up a calibrated noise source. Thanks very much.

See you all at the next conference.

Stan

## Additional Notes from the SARA Annual Conference

The SARA Board of Directors voted to donate \$600 to NRAO for the purchase of additional bicycles for visitors (like our members) to use while on site.

At right- Tom Crowley, SueAnn Heatherly and Bill Lord.



President Bill Lord recognized several members for their service to SARA.

Certificates of Appreciation were presented to the following members for their radio astronomy outreach:



Tom Hagen at left with Bill Lord



Ken Redcap at left with Bill Lord



Bill Dean at left with Bill Lord



At left- Jim Brown was presented a Certificate of Appreciation for his service as Director.

At right- Melinda Lord was presented the President's award for her work as Treasurer, Journal Editor and outreach work.

Not present at the conference but also recognized with Certificates of



Appreciation were Jim Moravec (for outreach), Kerry Smith, Jon Wallace and Dick Flagg for service as Directors.



**SARA Officer and Director Election Results**

**Elected to Director Position for 2013 to 2015**



**Ken Redcap**



**Ciprian "Chip" Sufitchi**

**Elected to Director-At-Large Position for 2013 to 2015**



**Stan Nelson**



**Curt Kinghorn**

**Elected to Secretary 2013-2015**



**Tom Hagen**

**Elected to Treasurer 2013-2015**



**Melinda Lord**

# 2014 SARA Western Regional Conference

Bishop, California, USA on 22 and 23 March 2014

The 2014 SARA Western Regional Conference will be held at Bishop, California and the Owens Valley Radio Observatory on Saturday and Sunday, 22 and 23 March 2014. OVRO is operated by California Institute of Technology and is located about 11 airline miles southeast of Bishop (driving distance is closer to 20 miles).

From the OVRO website (<http://www.ovro.caltech.edu/>): *"The Owens Valley Radio Observatory (OVRO) is one of the largest university-operated radio observatories in the world. Known by locals as 'The Big Ears', the observatory is located near Bishop, California, approximately 250 miles north of Los Angeles on the east side of the Sierra Nevada. For reference, its coordinates are [37:14:02N latitude, 118:16:56W longitude](#) at 1222 meters above sea level. ... CARMA is the Northern Hemisphere's most powerful millimeter-wave radio astronomy observatory."* Coordinates for the CARMA – Combined Array for Research in Millimeter-wave Astronomy – are [37°16'49.89" N, 118°08'29.58" W](#). Image below from <http://www.ovro.caltech.edu/>



**Call for papers:** Papers are welcome on subjects directly related to radio astronomy including hardware, software, education and tutorials, research strategies, observations and data collection and philosophy. If you wish to present a paper please email a letter of intent, including a proposed title and abstract to the conference coordinator at [westernconference@radio-astronomy.org](mailto:westernconference@radio-astronomy.org) no later than 31 December 2013. Be sure to include your full name, affiliation, postal address, and email address, and indicate your willingness to attend the conference to present your paper. Submitters will receive an email response, typically within one week.

**Presentations and proceedings:** In addition to presentations by SARA members, we plan to have speakers from OVRO and we have arranged for Dr. Tony Phillips from Spaceweather.com to make a presentation (more details to follow). Papers and presentations on radio astronomy hardware, software, education, research strategies, philosophy, and observing efforts and methods are welcome. Formal proceedings will be published for this conference. If presenters want to submit a paper or a copy of their presentation, we will make them available to attendees on CD.

**Basic schedule:** Our first day will be spent at Owens Valley Radio Observatory with presentations by SARA members and supporters and OVRO staff followed by a CARMA tour in the nearby mountains. Our second

day will be at a conference room in Bishop with presentations by SARA members and supporters.

**Contact:** Please contact conference coordinator Whit Reeve if you have any questions or if you would like to help with the conference: [westernconference@radio-astronomy.org](mailto:westernconference@radio-astronomy.org).

**Getting there:** Bishop and OVRO are located in a valley between the eastern Sierra Nevada and White Mountains. Because of the remote location we recommend conference participants make their travel plans and hotel and rental car reservations early. Possibilities are to fly into Los Angeles (LAX) or Las Vegas (LAS). If you decide to fly to Los Angeles, it is possible you can connect into the regional airport at Mammoth Lakes (MMH), 50 miles to the north of Bishop. The airline traveling into Mammoth is Alaska Airlines/Horizon, which has marketing agreements with a number of airlines including American Airlines. An Alaska/Horizon or American flight into LAX and a connecting flight into Mammoth would not require a terminal change to make the connection. From Mammoth, cars can be rented at the airport. Another possibility is to fly into Los Angeles or Las Vegas and then enjoy a scenic drive to Owens Valley, roughly 260 miles from LAX and 160 miles from LAS.

**Directions from Bishop to OVRO:** To drive from Bishop to OVRO, you need to drive through the city of Big Pine. Directions may be found on the OVRO website (see website link above). At the top of web page, click on [Information](#) and then on [Directions](#) in lower-left.

**Registration:** Registration for the 2014 Western Regional Conference is just US\$55.00. This includes breakfast and lunch on Saturday and Sunday. Payment can be made through PayPal, [www.paypal.com](http://www.paypal.com) by sending payment to [treasurer@radio-astronomy.org](mailto:treasurer@radio-astronomy.org). Please include in comments that the payment is for the **2014 Western Regional Conference**. You also can mail a check payable to SARA, 2189 Redwood Ave, Washington, IA 52353, USA. Please include an e-mail address so a confirmation can be sent to you when we receive your payment.

**Hotel reservations:** Contact the Creekside Inn in Bishop for reservations. We could not reserve rooms because they required up-front payment. To get the best rate and reserve your desired room type, we recommend contacting the hotel as soon as possible. Current rates (as of 26 July 2013) are: King Mountain View: \$109.99, King Creekside with Balcony: \$119.99, King Creekside with Patio: \$129.99. Call Creekside Inn at +1 800-273-3550 or make reservations at <http://www.bishopcreeksideinn.com>. In case your plans change at the last minute, Creekside Inn has a 24 hour cancellation policy.



**Saturday night dinner:** We will make a group dinner reservation at a local restaurant for Saturday night.

**Additional Information:** Additional details will be published online at [www.radio-astronomy.org](http://www.radio-astronomy.org) and in the SARA journal, *Radio Astronomy*, as we get closer to the conference date.

## CALL FOR PAPERS

### ~ 2014 SARA Western Regional Conference ~

Bishop, California and Owens Valley Radio Observatory, USA

The Society of Amateur Radio Astronomers (SARA) hereby solicits papers for presentation at its 2014 Western Regional Conference to be held 22 and 23 March 2014. Our first day will be spent at Owens Valley Radio Observatory with presentations by SARA members and supporters and OVRO staff followed by a tour of the Combined Array for Research in Millimeter-wave Astronomy (CARMA) in the nearby mountains. Our second day will be at a conference room in Bishop with presentations by SARA members and supporters.

Papers are welcome on subjects directly related to radio astronomy including hardware, software, education and tutorials, research strategies, observations and data collection and philosophy.

SARA members and supporters wishing to present a paper should email a letter of intent, including a proposed title and abstract to the conference coordinator at [westernconference@radio-astronomy.org](mailto:westernconference@radio-astronomy.org) no later than 31 December 2013. Be sure to include your full name, affiliation, postal address, and email address, and indicate your willingness to attend the conference to present your paper. Submitters will receive an email response, typically within one week. Formal printed Proceedings will be published for this conference and all presentations can be made available on CD.

Additional information and a schedule can be found on SARA's website: [www.radio-astronomy.org](http://www.radio-astronomy.org)

## Mark Your Calendar

February 7-9, 2014 Orlando, Florida Hamcation <http://www.radio-astronomy.org/node/147> SARA will have a booth at this event. Contact Tom Crowley [crowleytj@hotmail.com](mailto:crowleytj@hotmail.com) to volunteer.

March 22-23, 2014 SARA Western Regional Conference, Owens Valley Radio Observatory and Bishop, CA <http://www.radio-astronomy.org/node/147>

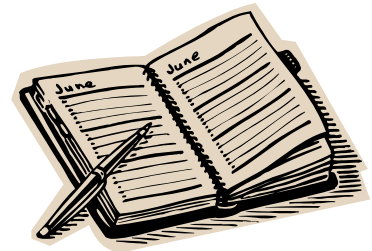
May 16-18, 2014 Dayton, Ohio Hamvention <http://www.hamvention.org/index.php> SARA will have a booth at this event. Contact Bill Lord at [ap\\_guardian\\_at\\_yahoo.com](mailto:ap_guardian_at_yahoo.com) to volunteer.

June 6, 2014 Astronomy on the National Mall, Washington, DC This event is hosted by Hofstra University, Department of Physics and Astronomy. Contact Bill Lord at [ap\\_guardian\\_at\\_yahoo.com](mailto:ap_guardian_at_yahoo.com) to volunteer.

June 29- July 2, 2014 SARA Annual Conference, National Radio Astronomy Observatory, Green Bank, West Virginia <http://www.radio-astronomy.org/?q=node/124>

July 2- July 4, 2014 Radio Jove Conference, National Radio Astronomy Observatory, Green Bank, West Virginia

Do you have an event to share with SARA members? Send information to [editor@radio-astronomy.org](mailto:editor@radio-astronomy.org) to be included in the next issue.



# Ruby Payne-Scott, the First Female Radio Astronomer

Jeffrey M. Lichtman

SARA Founder, Director Emeritus

Awhile ago, I read the news headlines on Google, This title caught my eye,  
**Ruby Payne-Scott: the first female radio astronomer** (Posted on [May 28, 2012](#) by [Gerald Ferreira](#)).

I selected the piece and was blown away! How did this piece of history elude me for so many years? I'm not saying I know everything about Radio Astronomy but this is really something!!

In the article, by [Gerald Ferreira](#) as well as Wikipedia, *Ruby Violet Payne-Scott*, BSc (Phys) MSc DipEd (Syd) (28 May 1912 – 25 May 1981) was an [Australian](#) pioneer in [radio physics](#) and [radio astronomy](#), and was the first female radio astronomer.

Ruby Payne-Scott was born in [Grafton, New South Wales](#), Australia, on 28 May 1912. She later moved to [Sydney](#) to live with her aunt, and completed secondary schooling at [Sydney Girls High School](#).<sup>[1]</sup>

She won two scholarships to undertake tertiary education at the [University of Sydney](#), where she completed a [B.Sc.](#) in Physics in 1933, an [M.Sc.](#) in 1936, and a [Diploma of Education](#) in 1938.

One of the more outstanding physicists<sup>[2]</sup> that Australia has ever produced and one of the first people in the world to consider the possibility of [radio astronomy](#), and thereby responsible for what is now a fundamental part of the modern lexicon of science, she was often the only woman in her classes at the [University of Sydney](#).

Her career arguably reached its zenith while working for the [Australian government's Commonwealth Scientific and Industrial Research Organization](#) (then called CSIR, now known as CSIRO) at [Dover Heights, Hornsby](#) and especially [Potts Hill](#) in [Sydney](#). Some of her fundamental contributions to solar radio astronomy came at the end of this period. She is the discoverer of Type I and Type III bursts and participated in the recognition of Type II and IV bursts. Payne-Scott played a major role in the first-ever radio astronomical [interferometer](#) observation from 26 January 1946, when the sea-cliff interferometer was used to determine the position and angular size of a solar burst. This observation occurred at either Dover Heights (ex Army shore defense radar) or at [Beacon Hill](#), near [Collaroy](#) on Sydney's north shore (ex Royal Australian Air Force surveillance radar establishment - however this radar did not become active until early 1950).

During [World War II](#), she was engaged in [top secret](#) work investigating [radar](#). She was the expert on the detection of aircraft using PPI ([Plan Position Indicator](#)) displays. She was also at the time a member of the Communist Party and an early advocate for [women's rights](#). The [Australian Security Intelligence Organization](#) (ASIO) was interested in Payne-Scott and had a substantial file on her activities, with some distortions.

## **Acknowledgements**

- [Gerald Ferreira](#)
- [http://en.wikipedia.org/wiki/Ruby\\_Payne-Scott](http://en.wikipedia.org/wiki/Ruby_Payne-Scott)



Payne-Scott as a student in the 1930s, possibly while she was studying at the University of Sydney (1929-1932)

Text is available under the [Creative Commons Attribution-Share Alike License](#); additional terms may apply. Wikipedia® is a registered trademark of the [Wikimedia Foundation, Inc.](#), a non-profit organization.

CSL ARTICLE 6/3/2012

## Will the first Female Radio Astronomer Stand Up

Jeffrey M. Lichtman

A short while ago, I sent in an article on the first Female Radio Astronomer, Ruby Payne Scott. My words were at that time *“I selected the piece and was blown away! How did this piece of history elude me for so many years? I’m not saying I know everything about Radio Astronomy but this is really something!!”*

I shared the find with a good friend in the UK, Mr. Colin Clements, also an avid Radio Astronomer. Today, Colin sent me a note;

I received your email concerning Ruby Payne-Scott; I was well aware of her background and historical involvement in Radio Astronomy, but the claim that she was the first woman Radio Astronomer is *highly controversial*. Many believe (myself included) that the honor rightly belongs to Dr. Elizabeth Alexander. Please refer to the following web-site:-

[www.mendeley.com/research/dr-elizabeth-alexander-first-female-radio-astronomer/](http://www.mendeley.com/research/dr-elizabeth-alexander-first-female-radio-astronomer/)

Another NASA / Smithsonian web-site agrees with this.

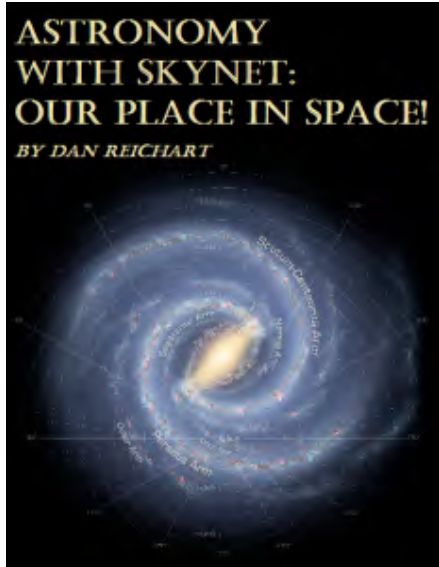
Well, needless to say again *I was blown away!* The story of Dr. Elizabeth Alexander follows:

During March–April 1945, solar radio emission was detected at 200 MHz by operators of a Royal New Zealand Air Force radar unit located on Norfolk Island. Initially dubbed the ‘Norfolk Island Effect’, this anomalous radiation was investigated throughout 1945 by British-born Elizabeth Alexander, head of the Operational Research Section of the Radio Development Laboratory in New Zealand. Alexander prepared a number of reports on this work, and in early 1946 she published a short paper in the newly-launched journal, *Radio & Electronics*. A geologist by training, Elizabeth Alexander happened to be in the right place at the right time, and unwittingly became the first woman in the world to work in the field that would later become known as radio astronomy. Her research also led to further solar radio astronomy projects in New Zealand in the immediate post-war year, and in part was responsible for the launch of the radio astronomy program at the Division of Radio physics, CSIRO, in Sydney.

[www.mendeley.com/research/dr-elizabeth-alexander-first-female-radio-astronomer/](http://www.mendeley.com/research/dr-elizabeth-alexander-first-female-radio-astronomer/)

### Astro with Skynet: Our Place In Space!

Dan Reichart was the keynote speaker at the Annual Conference in Green Bank, WV. Here is more information about using the remote control telescopes of SkyNet. This course is for optical astronomy, but they will be offering access to radio telescopes like the 20 meter telescope at NRAO in the future.



In *Astronomy with Skynet: Our Place In Space!*, we [learn how to use robotic telescopes in the Chilean Andes and around the world](#), and use these telescopes to observe planets, moons, asteroids, binary and variable stars, supernovae, star-forming regions, star clusters, and galaxies. Through these observations, we explore the following topics in eight interactive lessons, or labs:

- The seasons
- The Galilean revolution
- The cosmic distance ladder
- The Great Debate
- Dark matter
- Hubble's law
- Dark energy

<http://skynet.unc.edu/introastro/ourplaceinspace/>

### Radio Observations Wanted

I am assisting Mr. Kotaro Miyake of NHK, Japan in pre-production of the documentary series called "The Cosmic Front." The Cosmic Front is a weekly documentary about space and astronomy. NHK is a nationwide public TV broadcaster in Japan similar to BBC. This is the series' English website: [http://www.nhk.or.jp/space/program\\_e/cosmic.html](http://www.nhk.or.jp/space/program_e/cosmic.html)

Currently, Mr. Miyake is working on a 60-minute episode about extrasolar planets with a focus on Tau Ceti. Mr. Miyake would like to cover the years of research in this field starting from Project Ozma to the latest research findings. We would like to introduce radio observations by amateur astronomers in our program. We are hoping to meet an astronomy enthusiast who has built or set up radio observatory or telescope on his or her property, and who is particularly interested in Tau Ceti and has been observing Tau Ceti for a while. I am wondering if you would consider introducing some of your members to us. We are willing to travel to anywhere in the U.S. or Canada or even abroad to visit in September or October.

Let me know if you have any questions for us. I'd be happy to call you to answer any questions you may have.

Sincerely,

Tomoko Kawasumi  
Washington International Business Ventures  
E-mail: [tomoko@wibv.com](mailto:tomoko@wibv.com)  
Phone: 1-703-599-5330 (Virginia, USA)  
WIBV's Website: [http://wibv.com/services/tv\\_production](http://wibv.com/services/tv_production)  
NHK's Website: <http://www.nhk.or.jp/english/>

## The Sun's Magnetic Field is about to Flip

"It looks like we're no more than 3 to 4 months away from a complete field reversal," says solar physicist Todd Hoeksema of Stanford University. "This change will have ripple effects throughout the solar system." Read the entire article and watch a video here. [http://science1.nasa.gov/science-news/science-at-nasa/2013/05aug\\_fieldflip/](http://science1.nasa.gov/science-news/science-at-nasa/2013/05aug_fieldflip/)

**SARA members that attended the 2010 Western Conference will recognize Dr. Phil Scherrer and the Wilcox Solar Observatory, which we toured.**

**At right-** The Wilcox Solar Observatory (WSO) located in the foothills just west of the [Stanford University](#) campus.



This image shows the Parkes telescope in Australia, part of the Commonwealth Scientific and Industrial Research Organization. Researchers, including a team member from NASA's Jet Propulsion Laboratory in Pasadena, used the telescope to detect the first population of radio bursts known to originate from beyond our galaxy.

## Radio Bursts Discovered From Beyond our Galaxy

Space Daily  
by Staff Writers  
Pasadena CA (JPL) Jul 10, 2013

Astronomers, including a team member from NASA's Jet Propulsion Laboratory in Pasadena, Calif., have detected the first population of radio bursts known to originate from galaxies beyond our own Milky Way. The sources of the light bursts are unknown, but cataclysmic events, such as merging or exploding stars, are likely the triggers.

To read all of the interesting details go to:

[http://www.spacedaily.com/reports/Radio\\_Bursts\\_Discovered\\_From\\_Beyond\\_our\\_Galaxy\\_999.html](http://www.spacedaily.com/reports/Radio_Bursts_Discovered_From_Beyond_our_Galaxy_999.html)

## PARI Featured in Sky and Telescope Article

The September 2013 issue of Sky and Telescope has a nice five page article about the Pisgah Astronomical Research Institute (PARI) in northwest North Carolina. Page 38 shows students building Radio Jove receivers. PARI works closely with schools to promote STEM projects to about 5000 grade school students each year. They also host undergraduate interns.

You can read the summer issue of the PARI Newsletter

[http://www.pari.edu/about\\_pari/newsletter/VIEWSummer2013final%20draft.pdf/](http://www.pari.edu/about_pari/newsletter/VIEWSummer2013final%20draft.pdf/).



## Preamplifiers for Callisto Solar Radio Spectrometer

Whitham Reeve and Christian Monstein

### 1. Introduction

We investigated the performance of three amplifiers (figure 1) for Callisto applications by measuring their noise figure, gain, overload compression and S-parameters. Two amplifiers of special importance to us because of their low noise characteristics are the Mini-Circuits ZX60-33LN-S+ and an unbranded unit obtained from China through eBay from seller “kitmanlaw2008” (the unit is believed to be FM User or chzfmtransmitter.com model E201). We call the Chinese amplifier CxLNA. Both amplifiers are advertised as low noise amplifiers with approximately 1.0 dB noise figure and 20 dB gain.



Figure 1 ~ Amplifiers, from top: ZX60-33LN-S+, ZKL-2, and CxLNA

Our measurements show very similar performance of these two amplifiers in our labs. The CxLNA has advantages of cost and an internal voltage regulator that allows it to be used with the same 12 Vdc power supply as the Callisto (the ZX60 has a maximum input voltage of 5.5 Vdc and requires a step-down power supply). Also, the CxLNA amplifier has slightly higher gain than the ZX60 at frequencies below 200 MHz.

We also performed comparative measurements on the Mini-Circuits ZKL-2. This amplifier has much higher gain of 31 dB but also a higher noise figure of 4 dB. This amplifier was evaluated for use as an intermediate amplifier where long coaxial cable runs are used between a remote low noise preamplifier, such as the ZX60 or CxLNA, and the Callisto. It also has applications as an intermediate frequency (IF) amplifier in up- and down-converters used with Callisto or other systems.

The basic data for the three amplifiers are summarized (table 1). Each set of measurements is described in separate sections below followed by a brief description of amplifier construction and measurement methods. All measurements involving a Callisto were made at Anchorage, Alaska using Callisto s/n NA008.

Table 1 ~ Amplifier basic specifications

Model	Manufacturer	Frequency (MHz)	Gain (dB)	Noise figure (dB)	Voltage (V)	Current (mA)	Price (US\$)	Notes
ZX60-33LN-S+	Mini-Circuits	50 to 3000	19	1.1	3.3 to 5.0	80	80	Note 1
CxLNA	Unknown	20 to 1000	20	0.6	8 to 14	40	61	Note 2
ZKL-2	Mini-Circuits	10 to 2000	33	4	9 to 12	120	150	Note 1

Table notes:

1. The specifications shown are from the manufacturer's datasheet. Prices do not include shipping.
2. The manufacturer and model number of this amplifier are unknown, so it was given the designation CxLNA; CxLNA1 in the test results indicates one of several amplifiers. The input current for the CxLNA was measured at 12.0 Vdc input. The price includes free shipping to US destinations.

## 2. Noise Figure

The noise figures were measured at 200 individual frequencies spaced evenly in the Callisto frequency band (figure 2). These measurements agreed quite well with the datasheet values.

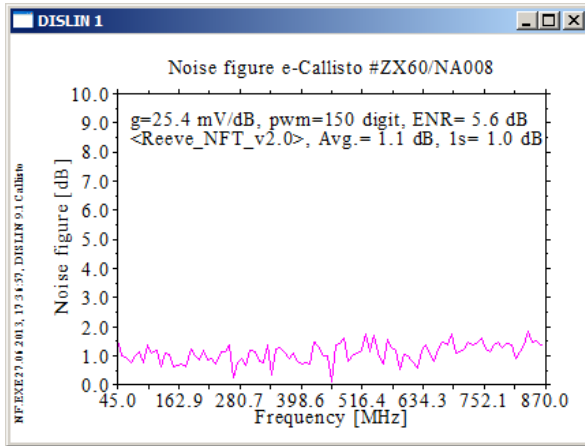
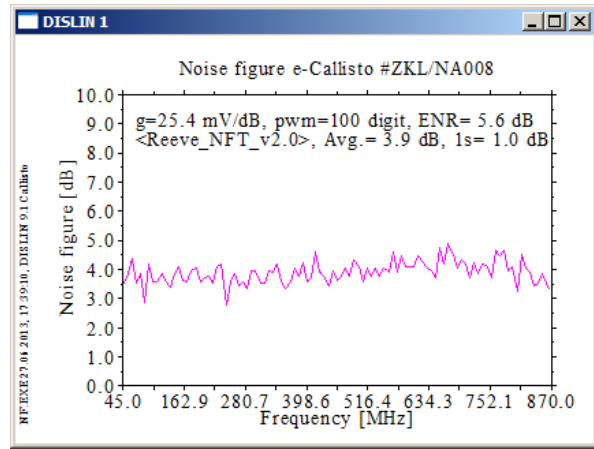
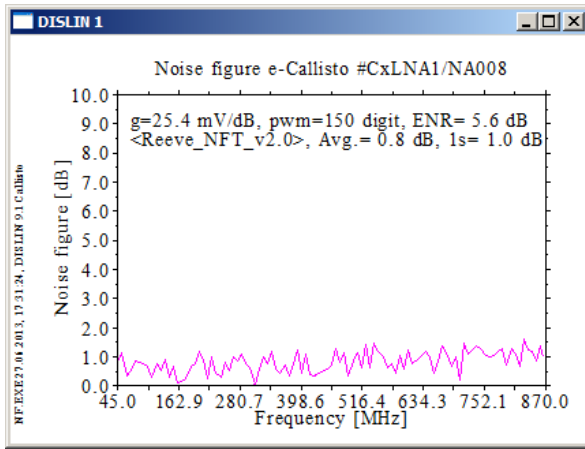


Figure 2 ~ Amplifier noise figure measurements. The amplifier type is indicated on the top text line of the noise figure plots (CxLNA1 is the Chinese amplifier, ZKL is a Mini-Circuits ZKL-2+ and ZX60 is a Mini-Circuits ZX60-33LN-S+). The text data at the top of the plots indicates details of the measurement and the average (Avg.) and standard deviation (1s) of the noise figure. All measurements were made in conjunction with Callisto s/n NA008 using the NF software tool v2.0. Note that the Callisto gain was reduced for measurement of the higher gain ZKL amplifier.

### 3. Gain

The power gain of the three amplifiers varies a little with frequency; for the ZX60 and CxLNA, gain decreases with increasing frequency (figure 3).

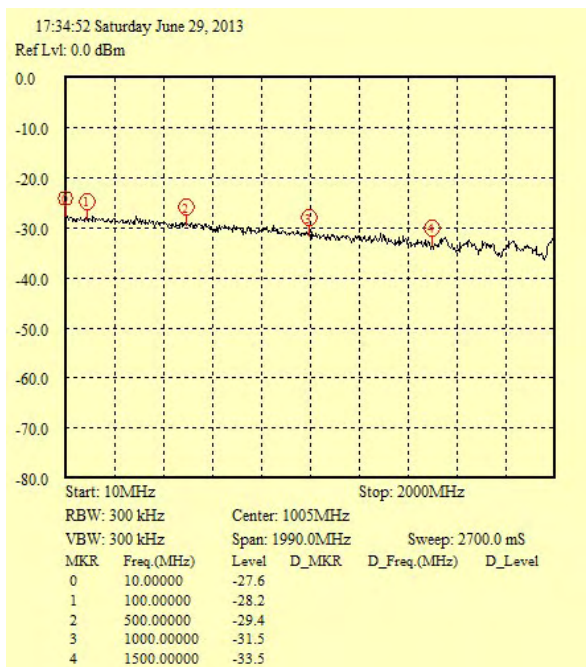
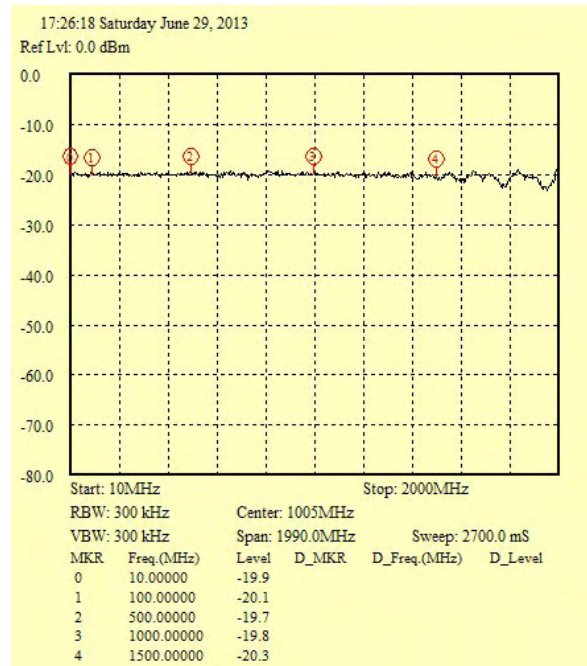
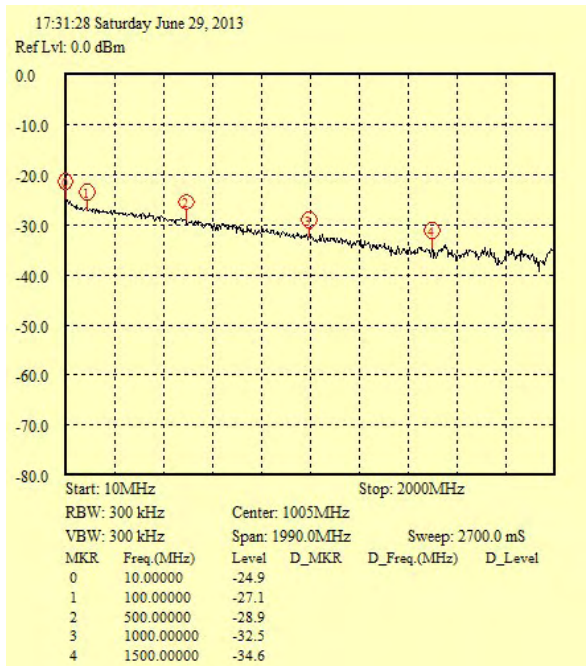


Figure 3 ~ Amplifier gain over the frequency range 10 to 2000 MHz. CxLNA1: Upper-left; ZKL: Upper-right; ZX60: Lower-left.

The tracking generator output level for all measurements was -30 dBm, and 10 dB attenuators were placed on the amplifier input and output for isolation. Therefore, gain = Indicated level + 50 dB. Some of the loss indicated on the plots for higher frequencies is due to the connecting cables and connectors. Connecting cables were 50 cm long RG-142 coaxial cables and SMA-M/N-F adapters were required to adapt the cables to the amplifier connectors.

#### 4. Overload compression

The response of the amplifiers was measured at high input powers to determine the point at which the output becomes compressed 1 dB due to overload (figure 4). For the ZX60 and CxLNA, the 1 dB compression point is about -3 dBm and for the ZKL is about -12 dbm. Both values are much higher than the expected operating levels for the Callisto applications as a solar radio spectrometer except where the antenna is directly pointing toward a nearby transmitter.

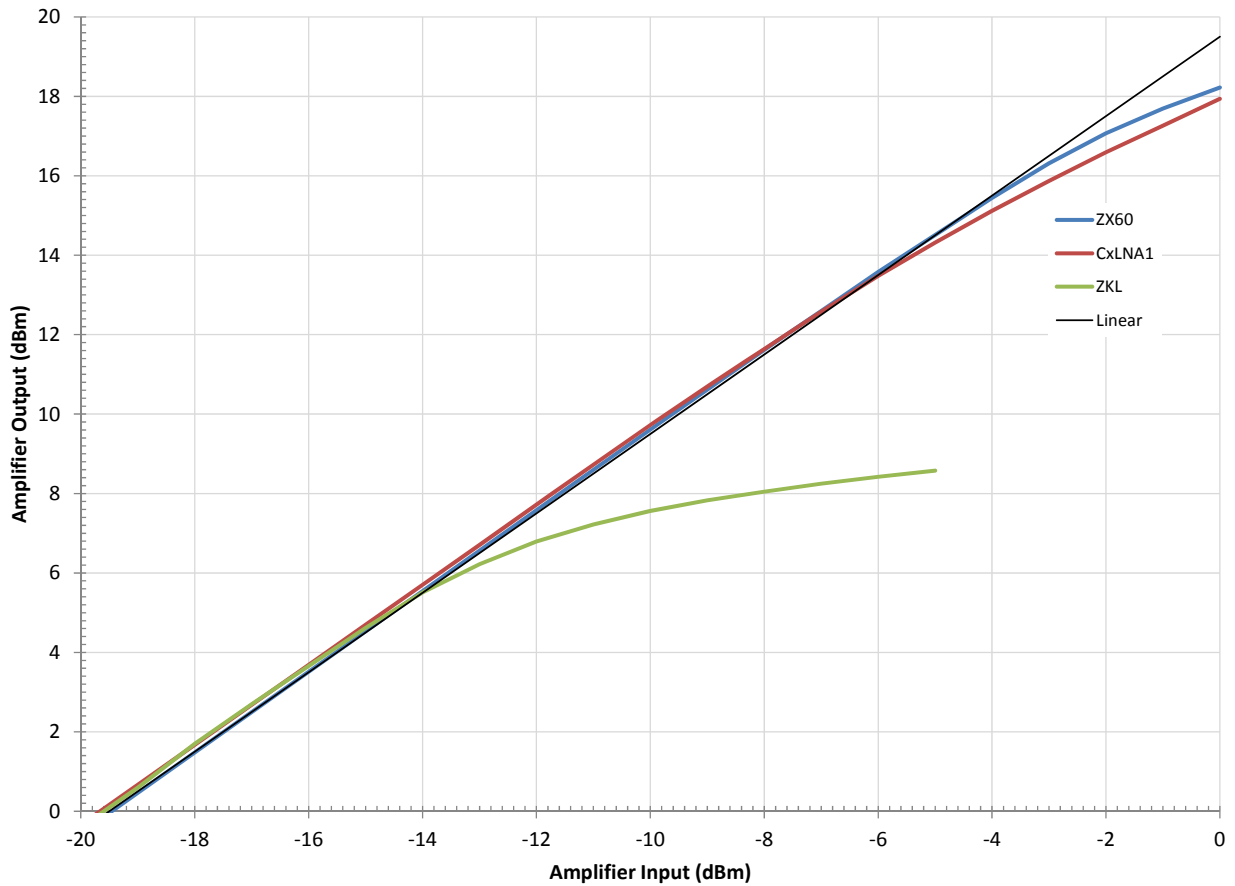


Figure 4 ~ Overload compression for the three amplifiers at 457.5 MHz. This was a 1 dB compression point measurement, where the linearity of the amplifier changes by 1 dB. The ZX60 and CxLNA have nearly identical performance at high input powers, with the compression point approximately  $-3$  dBm. The higher gain ZKL amplifier has a much lower compression point at approximately  $-12$  dBm. A linear trend line also is shown.

## 5. General spectral performance

Several measurements were made to evaluate general performance with live signals received on a collapsible whip antenna. The main purpose of these tests was to find evidence of amplifier overload in a high RFI environment, but we found none.

The spectrum plots (figure 5) show relative power (Y) as a function of frequency (F). All spectrum plots were taken at Anchorage, Alaska. Very strong signals are apparent in the FM broadcast band (88 to 108 MHz), VHF air navigation and communications band (108 to 137 MHz), TV broadcast bands (54 to 88, 174 to 216 and 470 to 692 MHz) and mobile radio services above (864 MHz and above).

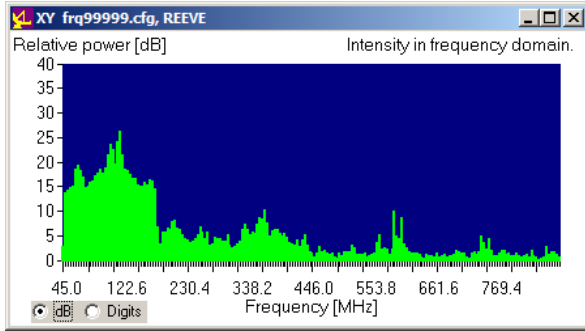
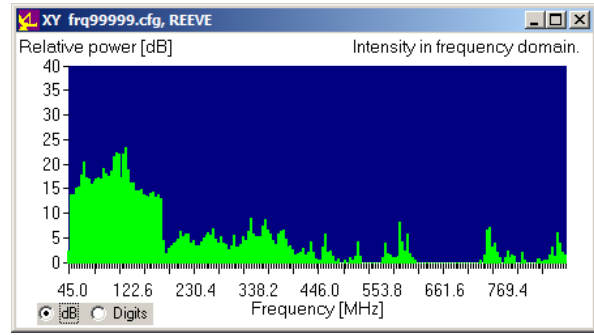
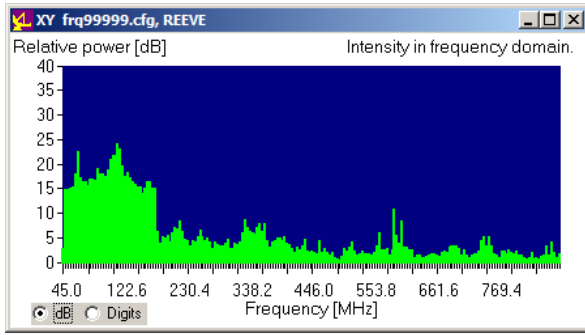


Figure 5 ~ Live spectrum  $y(f)$  plots produced by Callisto software with 200 channels distributed evenly throughout the Callisto frequency range. All measurements are with respect to the background noise (amplifier + Callisto). The amplifier outputs were connected directly to the Callisto RF Input port through a coaxial adapter. To obtain the relative measurements, the amplifier input was first connected directly to a 50 ohm termination resistor to obtain background noise level. No gain reduction was used with the ZKL amplifier. The plots were produced about 1 minute apart.

The live measurements with the whip antenna also were recorded to a flexible image transport system (FITS) file and then plotted. The FITS file contains one data element for each measurement of the received power (color, Y) as a function of frequency (F) and time (T) (figure 6). The power level measured at the output of the Callisto's internal logarithmic detector (AD8307) is encoded with 10-bit resolution but divided by 4 to reduce resolution to 8-bits for the FITS file. The application used to view the file (Java-based RAPP Viewer) allows the pixel associated with these three parameters to be read at the PC mouse position.

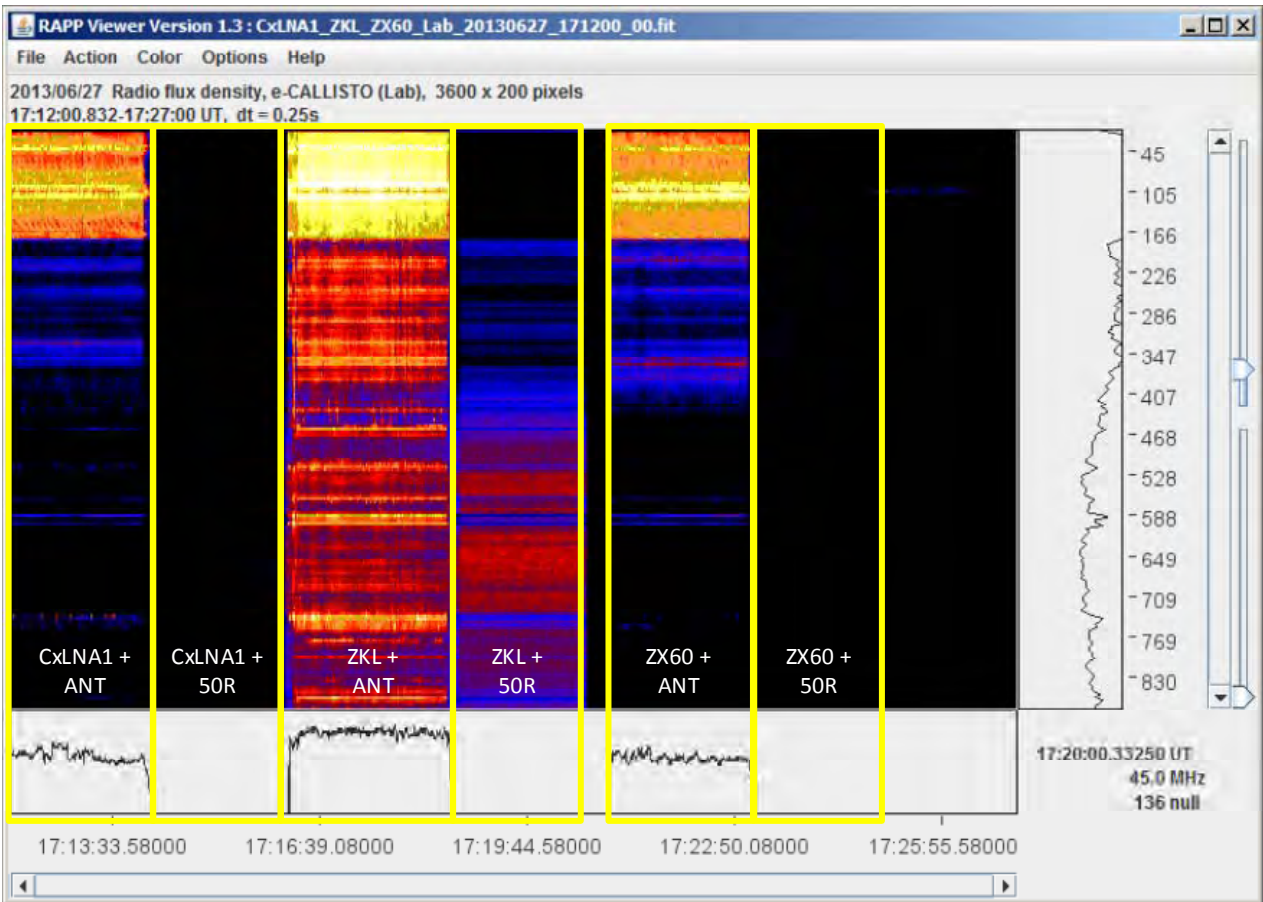


Figure 6 ~ Presentation of the FITS test file using the freely available Java-based RAPP Viewer application. The RFI received with the whip antenna in the various frequency bands previously mentioned is readily apparent. Of particular interest are the CxLNA1 at the beginning of the record and the ZX60 at the end. The ZKL is included in between for comparison. The Callisto gain was set to one value (PWM = 150) and not reduced for the ZKL amplifier. For these measurements each amplifier was first connected to the whip antenna for 2 minutes and then to a 50 ohm termination for 1.5 minutes, the latter to provide a comparatively quiet input. Pixel comparisons at several random points for the CxLNA1 and ZX60 revealed that for a given frequency, the received power level agreed within  $\pm 1$  digit out of 256 (8 bits).

## 6. Additional detailed Spectrum Measurements

The 0.5 m whip antenna was again used to measure the power of 200 channels evenly distributed within the Callisto frequency range. The results are plotted for the CxLNA1 and ZX60 amplifiers (figure 7) and ZKL amplifier (figure 8). These plots also show the spectrum response of the Callisto (NA008) alone for comparison.

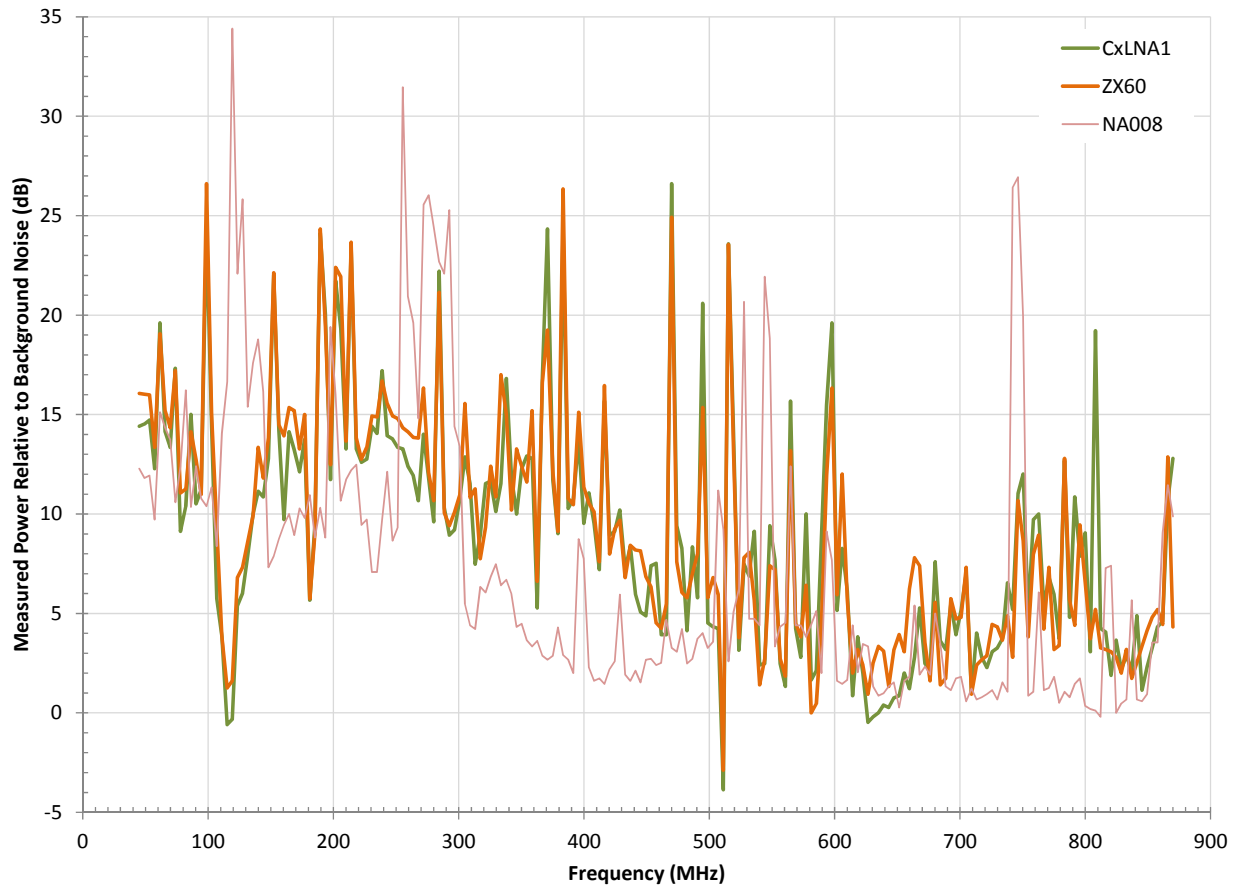


Figure 7 ~ Live spectrum for the CxLNA1 and ZX60 amplifiers and receiver compared to the receiver alone. The Callisto was setup to record the power for 200 channels evenly distributed in the 45 to 870 MHz frequency band. Callisto overload is indicated around 120 and 510 MHz where the relative response drops below 0 dB.



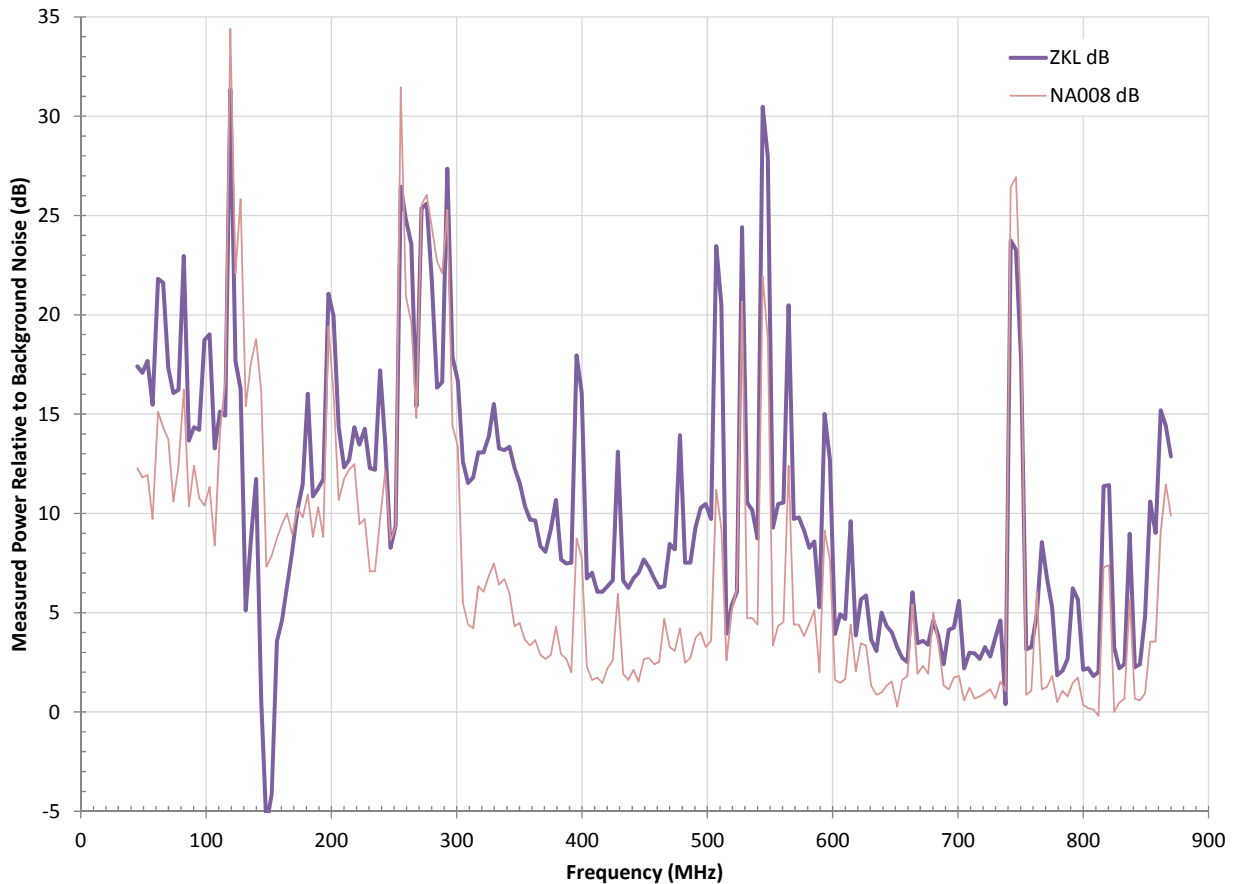


Figure 8 ~ Spectrum for the ZKL amplifier and receiver compared to the receiver alone. The Callisto was setup to record the power for 200 channels evenly distributed in the 45 to 870 MHz frequency band. Callisto overload is indicated around 150 MHz.

## 7. S-parameter measurements

The scattering parameters (s-parameters) were measured at ETH Zurich, Switzerland over a frequency range of 300 kHz to 3 GHz on the CxLNA (figure 9), ZX60 (figure 10) and ZKL (figure 11). The s21 measurements are equivalent to the forward gain measurements previously discussed. The s11 and s22 measurements indicate how well the inputs and outputs are matched to 50 ohm impedance, and the s12 measurements indicate the backward gain, or the amount of signal applied to the amplifier output that is coupled back through to the input. In the case of reflections or spurious signals coupled into the amplifier from the output transmission line, a low s12 may lead to self-excitation of the receiving system.

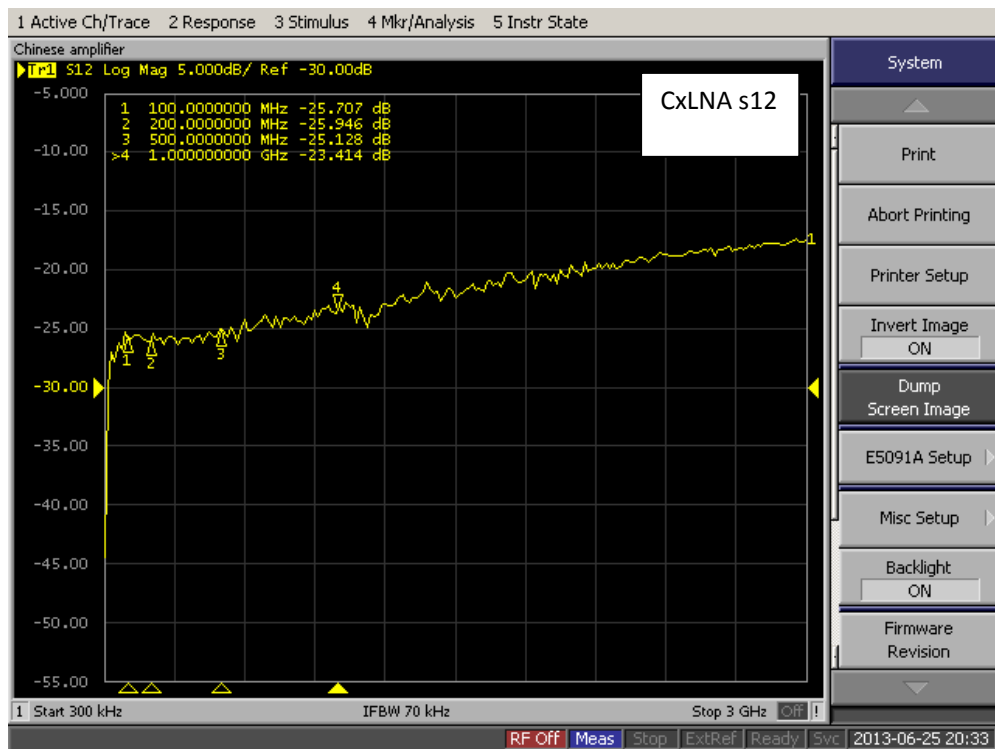
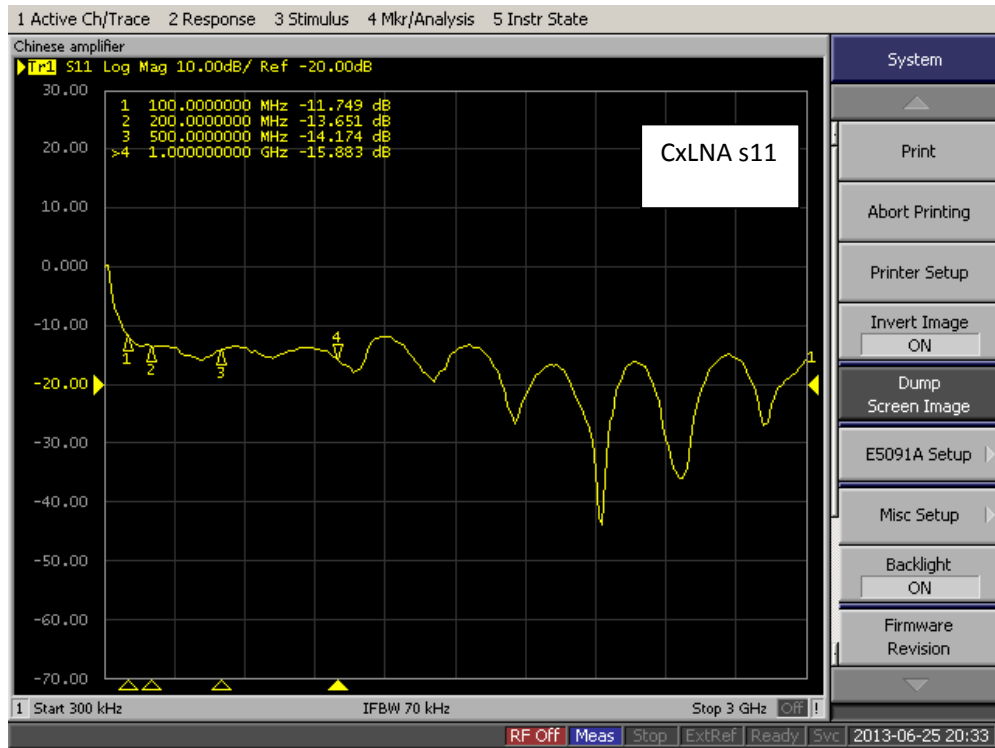
We were mainly concerned with the CxLNA and ZX60 amplifiers so we limit our comments on their comparative s-parameters to these:

s11: CxLNA has better input matching compared to 50 ohms above 200 MHz;

s12: ZX60 has slightly better backward gain (higher loss) above 500 MHz;

s21: CxLNA forward gain is slightly better below 200 MHz but slightly worse above 500 MHz;

s22: CxLNA has slightly better output matching compared to 50 ohms at most frequencies.



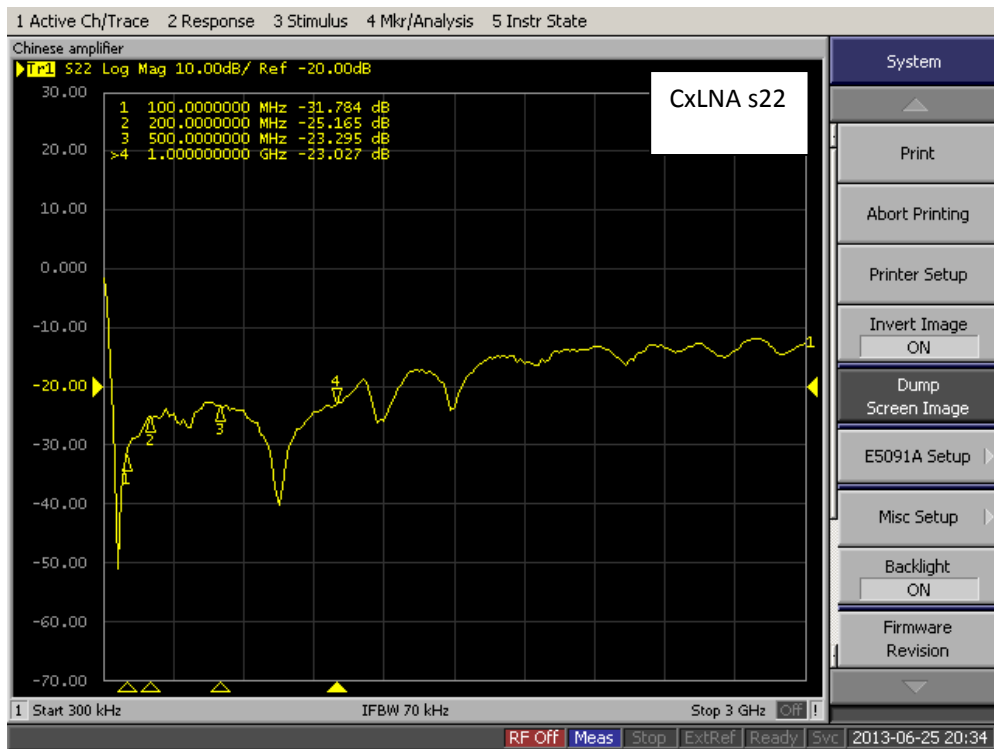
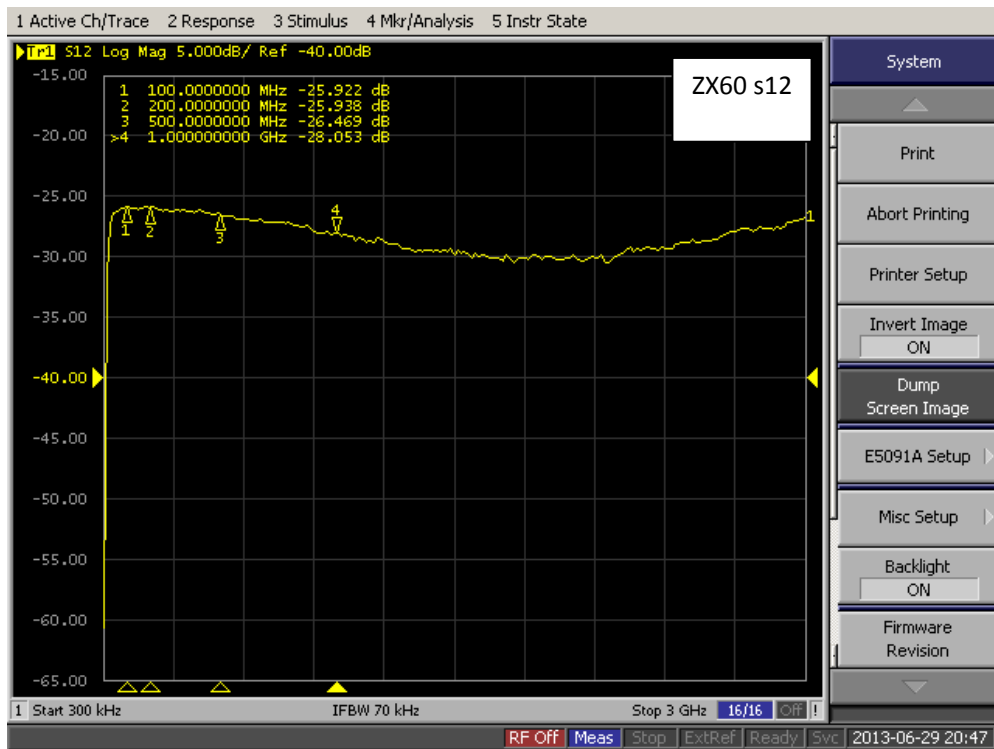
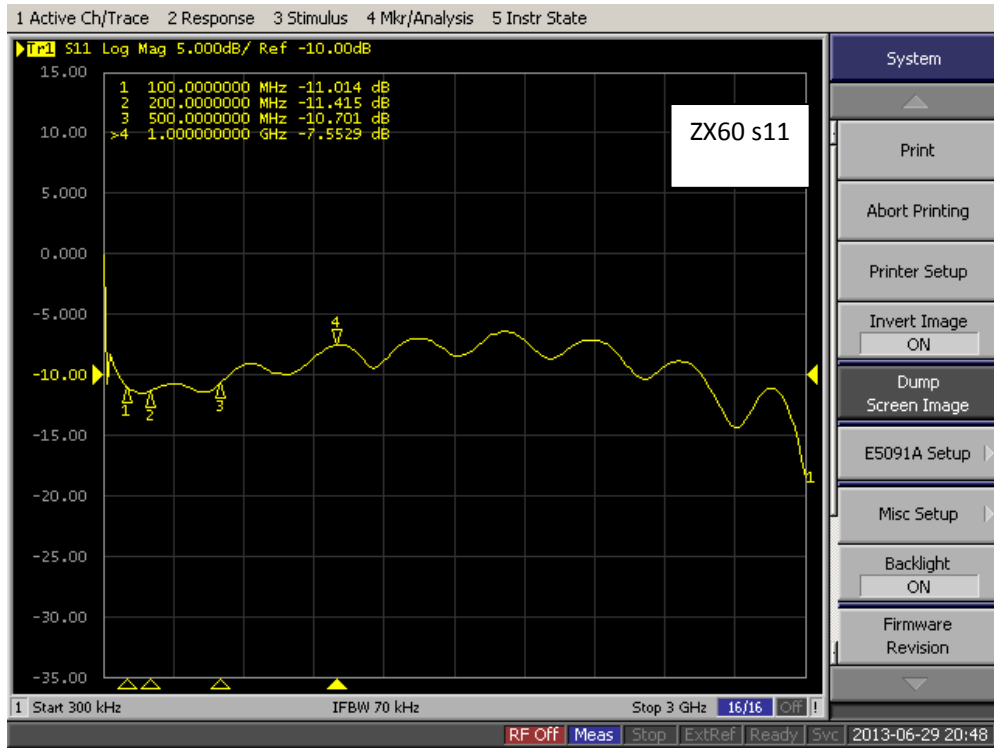


Figure 9 ~ CxLNA S-parameters



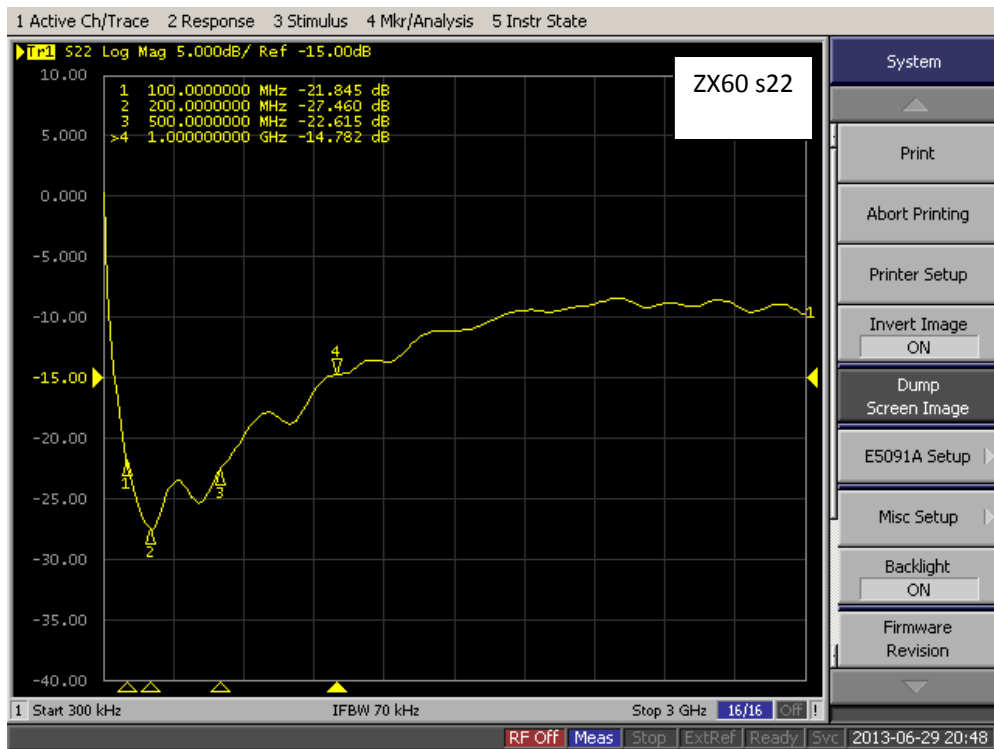
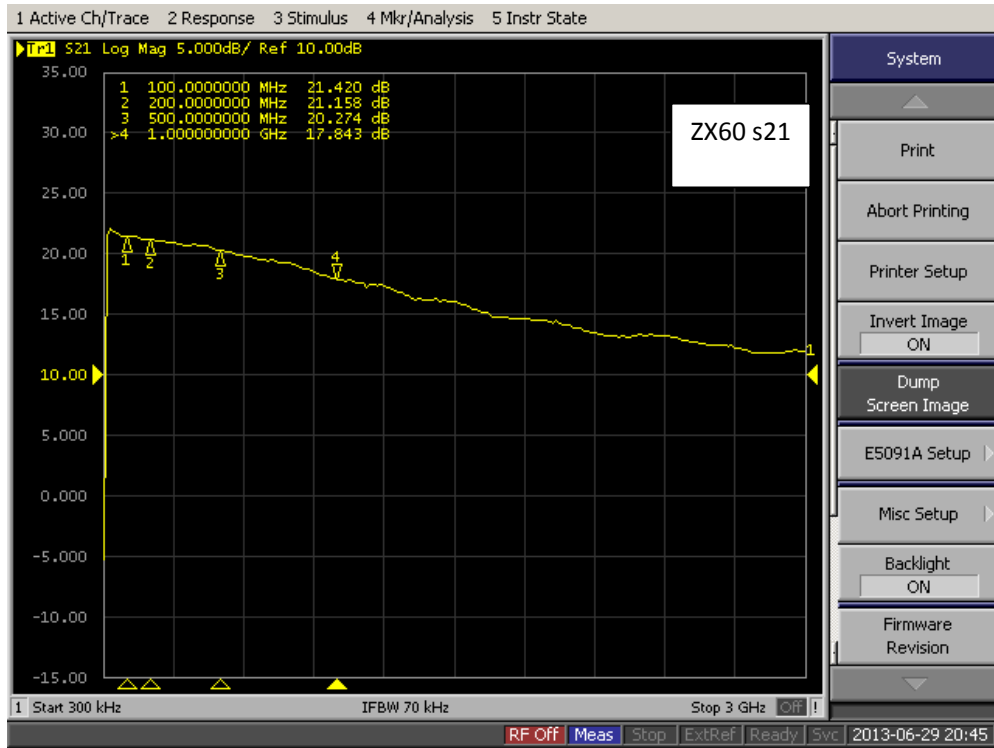
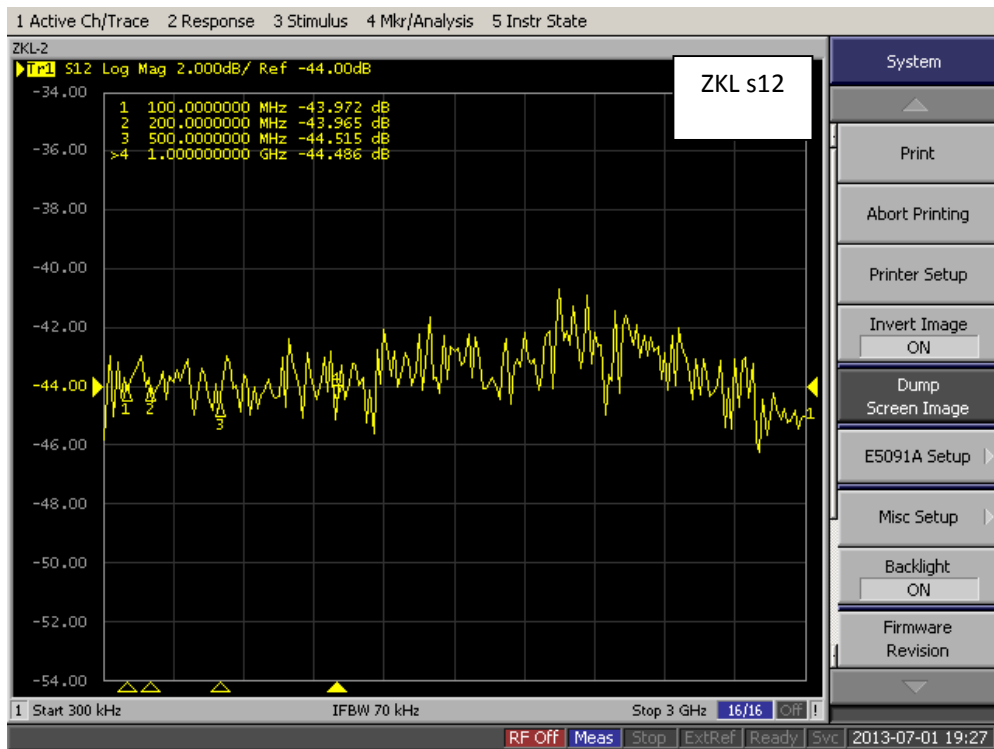
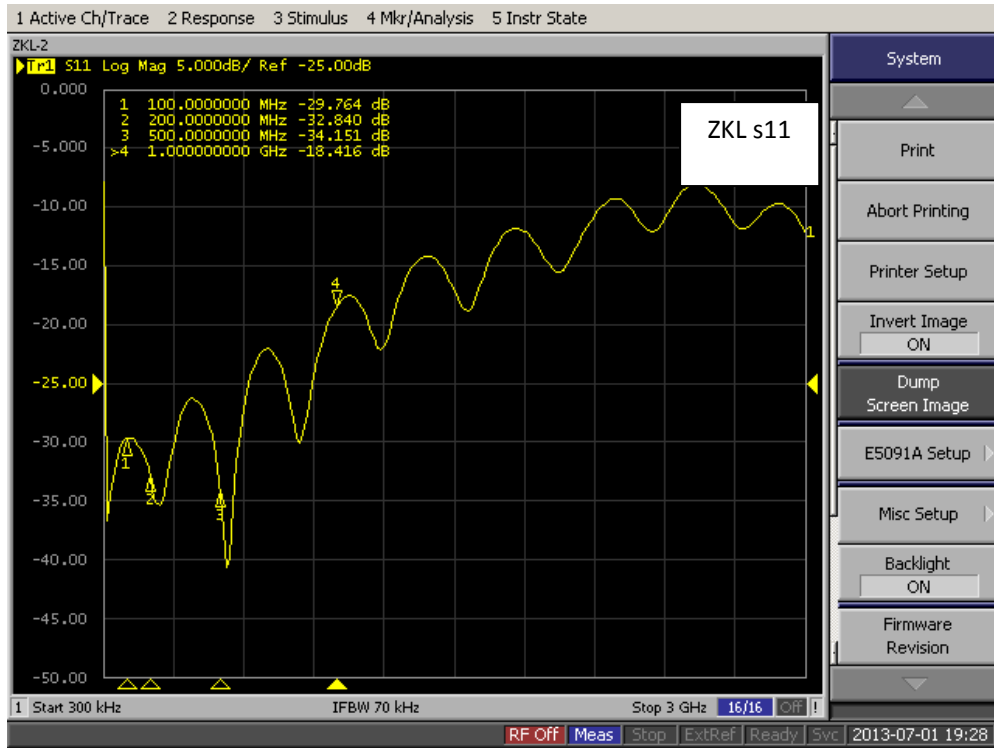


Figure 10 ~ ZX60 S-parameters



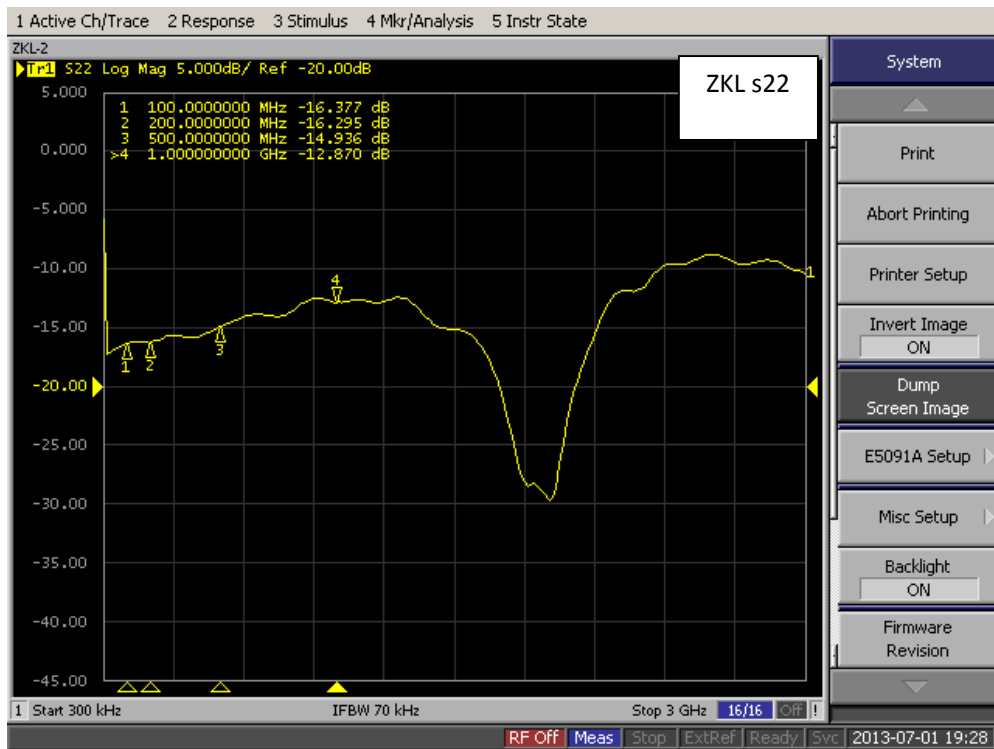
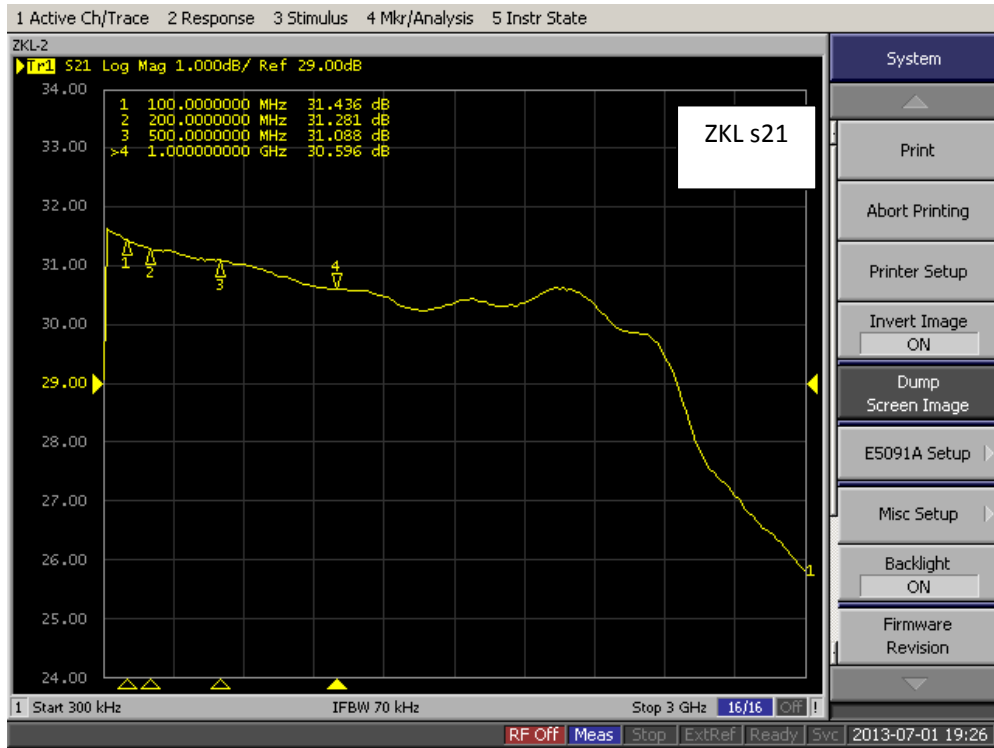


Figure 11 ~ ZKL S-parameters

## 8. Amplifier construction

The three amplifiers share the same basic construction – a machined aluminum enclosure with covers held by screws. Also, the three amplifiers all use SMA-F connectors for input and output, and power is connected by leads soldered to a feed-through capacitor and ground lug located near the output connector. The two Mini-Circuits amplifiers appear to be machine-built while the Chinese CxLNA appears to be hand-built (figure 12).

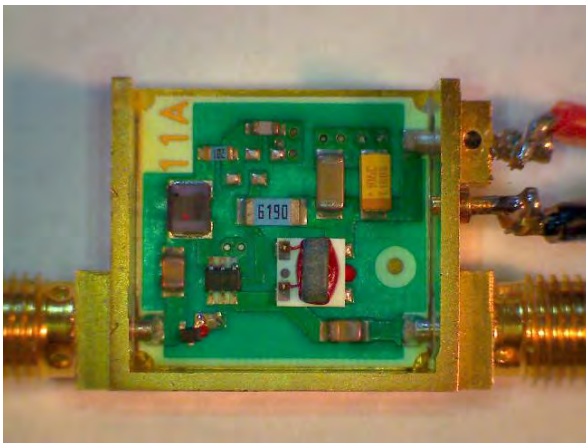
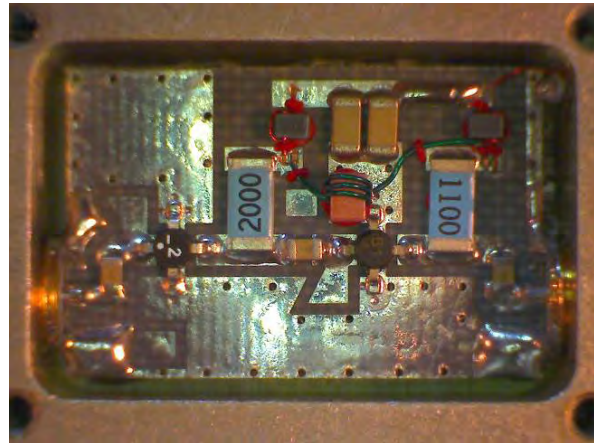
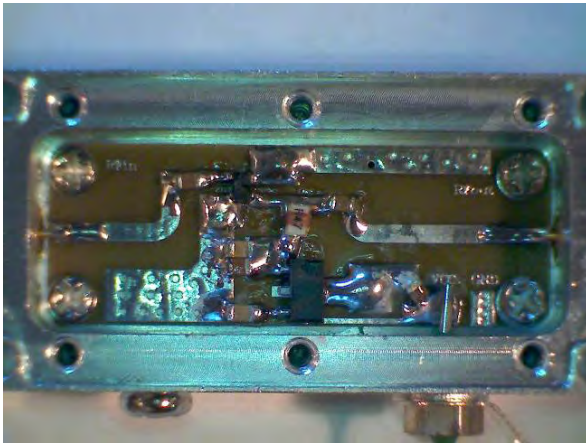


Figure 12 ~ Interior photographs. CxLNA1: Upper-left; ZKL: Upper-right; ZX60: Lower-left. For all amplifiers, input is on the left side. The magnification is the same for the ZKL and ZX60 and about 25% higher than the CxLNA.

The amplifier integrated circuit in the CxLNA is visible just to left of upper-center, and the voltage regulator IC is at the bottom-center. The ZKL appears to have two amplifier stages – just below middle-left and middle-right. Not visible in the ZKL picture are two conductive mesh cylinders below the PCB that bond the PCB to the bottom cover. The amplifier IC in the ZX60 is at bottom-left, very close to the input connector. All other components in the ZX60 appear to be related to power filtering and voltage regulation.

## 9. Methods

### Noise figure measurements:

The amplifiers were connected directly to the Callisto RF Input port through an SMA-M/N-M coaxial adapter (figure 13). The Callisto software tool NF, which uses the Y-factor method, and the RF Design RFD2305 noise source were used for the measurements. The RFD2305 has an excess noise ratio (ENR) of 5.8 dB in the



frequency range of interest. For calculation purposes, this was reduced by 0.2 dB to 5.6 dB to account for connection losses.

The amplifier noise figure measurements include amplifier noise as well as the effects of the Callisto. The gains of the CxLNA1 and ZX60 are approximately 20 dB and the noise figure of the Callisto is 7.5 dB, resulting in an amplifier noise measurement that is a few tenths dB higher than actual. Measurement uncertainty also amounts to at least a few tenths dB. The higher gain of the ZKL reduces the effect of the Callisto noise figure in the measurement.

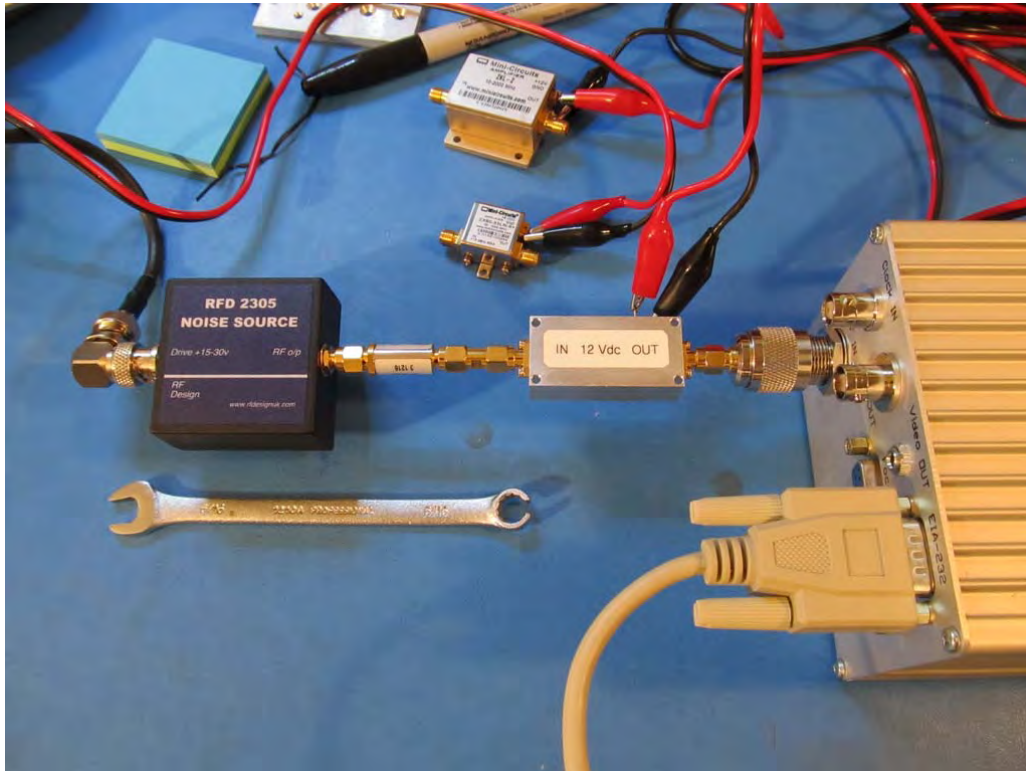


Figure 13 ~ Noise figure measurement setup for the CxLNA. The ZX60 and ZKL amplifiers used the same setup. The RFD2305 noise source (blue box on left) was connected directly to the RF Input of the amplifier through its 10 dB attenuator. The RFD2305 was factory calibrated with the attenuator, which can be seen between the blue box and amplifier. The amplifiers were connected to a power supply using temporary leads (red and black wires and alligator clips). The Callisto (right) was setup in the normal way with EIA-232 connection to the PC and power connection to a 12 Vdc lab power supply. The PC used the NF test tool.

#### Spectrum Y(F) measurements:

The spectrum measurements were produced with the Callisto software. The frequency file ran from 45 to 870 MHz with 200 channels evenly distributed within that band. A 0.5 m whip antenna was connected directly to the amplifier inputs. The amplifier outputs were connected directly to the Callisto RF input (figure 14). Callisto gain (PWM value) was set to 150 for all measurements.

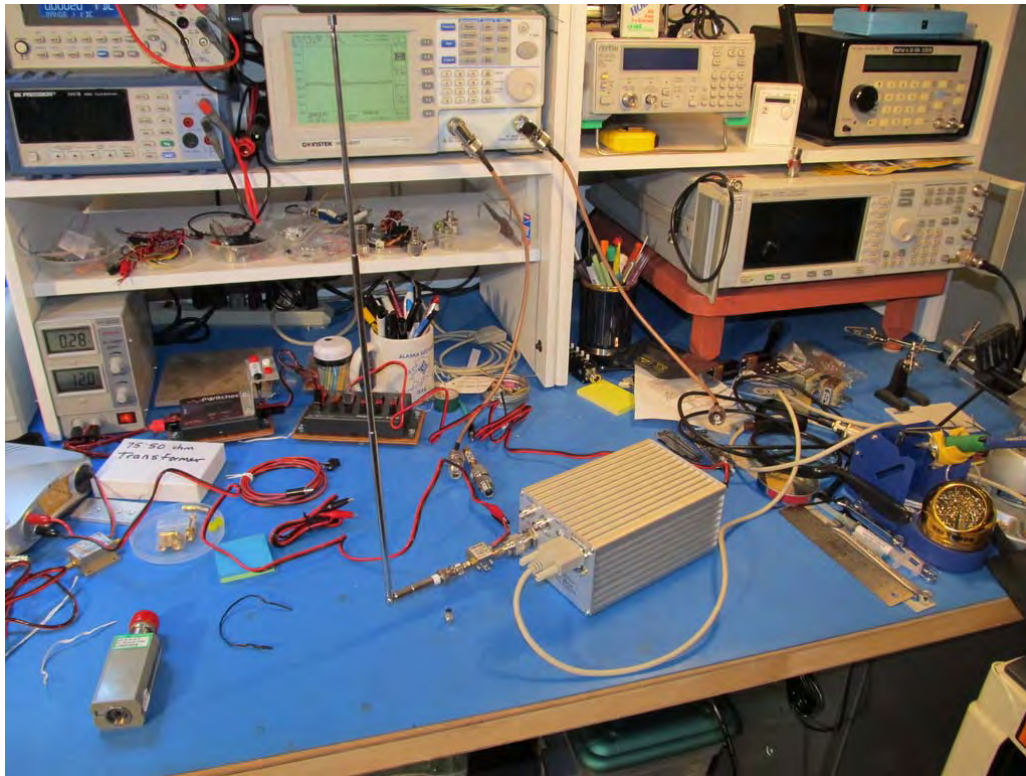


Figure 14 ~ Spectrum measurements setup. The amplifier output was connected directly to the Callisto RF input and a 0.5 m whip antenna connected to the amplifier input. The measurements were of the lab RFI environment as a substitute for live observations.

#### Gain measurements:

A spectrum analyzer with tracking generator (Instek GSP-827TG) was used for gain measurements. All amplifiers were isolated from the tracking generator/spectrum analyzer with 10 dB attenuators, resulting in an input level of  $-40$  dBm for the CxLNA1 and ZX60 and  $-50$  dBm for the ZKL. All amplifiers use SMA-F connectors for input and output, so adapters were used for connect the amplifiers to RG-142 coaxial test cables with N-M connectors.

#### Overload compression measurements:

For all overload measurements, the amplifier inputs were connected to an Agilent E4422B RF signal generator set to 457.5 MHz (mid-way between 45 and 870 MHz). Amplifier output power level was measured by an HP 437B RF power meter with HP 8481A sensor.

#### FITS:

The FITS file was produced with Callisto software v118 setup for 900 second (15 minute) measurement interval. The frequency file ran from 45 to 870 MHz with 200 channels evenly distributed within that band. The amplifier RF input was connected directly to a 0.5 m whip antenna, so the measurements were of the RFI environment in the Anchorage lab. Callisto s/n NA008 was used with the amplifiers for all measurements.

#### Detailed spectrum measurements:

The NF software tool v2.0 was used to produce measurement data for 200 channels within the frequency range of 45 to 870 MHz. As with the spectrum and FITS measurements, a 0.5 m whip antenna was connected to the amplifier RF input. Callisto s/n NA008 was used with the amplifiers for all measurements.

#### S-parameter measurements:

S-parameters were measured with an Agilent E5071B ENA RF Network Analyzer over a frequency range of 300 KHz to 3 GHz.

## 10. Weblinks

Chinese (CxLNA) amplifier:

<http://www.ebay.ch/itm/320989235933?ssPageName=STRK:MEWNX:IT& trksid=p3984.m1439.l2648>

<http://www.ebay.com/itm/320989235933?ssPageName=STRK:MEWNX:IT& trksid=p3984.m1497.l2649>

Mini Circuits ZX60-33LN: <http://www.minicircuits.com/pdfs/ZX60-33LN+.pdf>

Mini Circuits ZKL-2: <http://www.minicircuits.com/pdfs/ZKL-2.pdf>



### Quotable Quote

*"Physics is not a religion. If it were, we'd have a much easier time raising money."*

Leon M. Lederman (1922 - )

# High-energySpy

By Dr. Martin C. Weisskopf

The idea for the Chandra X-Ray Observatory was born only one year after Riccardo Giacconi discovered the first celestial X-ray source other than the Sun. In 1962, he used a sounding rocket to place the experiment above the atmosphere for a few minutes. The sounding rocket was necessary because the atmosphere blocks X-rays. If you want to look at X-ray emissions from objects like stars, galaxies, and clusters of galaxies, your instrument must get above the atmosphere.

Giacconi's idea was to launch a large diameter (about 1 meter) telescope to bring X-rays to a focus. He wanted to investigate the hazy glow of X-rays that could be seen from all directions throughout the sounding rocket flight. He wanted to find out whether this glow was, in fact, made up of many point-like objects. That is, was the glow actually from millions of X-ray sources in the Universe. Except for the brightest sources from nearby neighbors, the rocket instrument could not distinguish objects within the glow.

Giacconi's vision and the promise and importance of X-ray astronomy was borne out by many sounding rocket flights and, later satellite experiments, all of which provided years-, as opposed to minutes-, worth of data.

By 1980, we knew that X-ray sources exist within all classes of astronomical objects. In many cases, this discovery was completely unexpected. For example, that first source turned out to be a very small star in a binary system with a more normal star. The vast amount of energy needed to produce the X-rays was provided by gravity, which, because of the small star's mass (about equal to the Sun's) and compactness (about 10 km in diameter) would accelerate particles transferred from the normal star to X-ray emitting energies. In 1962, who knew such compact stars (in this case a neutron star) even existed, much less this energy transfer mechanism?

X-ray astronomy grew in importance to the fields of astronomy and astrophysics. The National Academy of Sciences, as part of its "Decadal Survey" released in 1981, recommended as its number one priority for large missions an X-ray observatory along the lines that Giacconi outlined in 1963. This observatory was eventually realized as the Chandra X-Ray Observatory, which launched in 1999.

The Chandra Project is built around a high-resolution X-ray telescope capable of sharply focusing X-rays onto two different X-ray-sensitive cameras. The focusing ability is of the caliber such that one could resolve an X-ray emitting dime at a distance of about 5 kilometers!  
The building of this major scientific observatory has many stories.

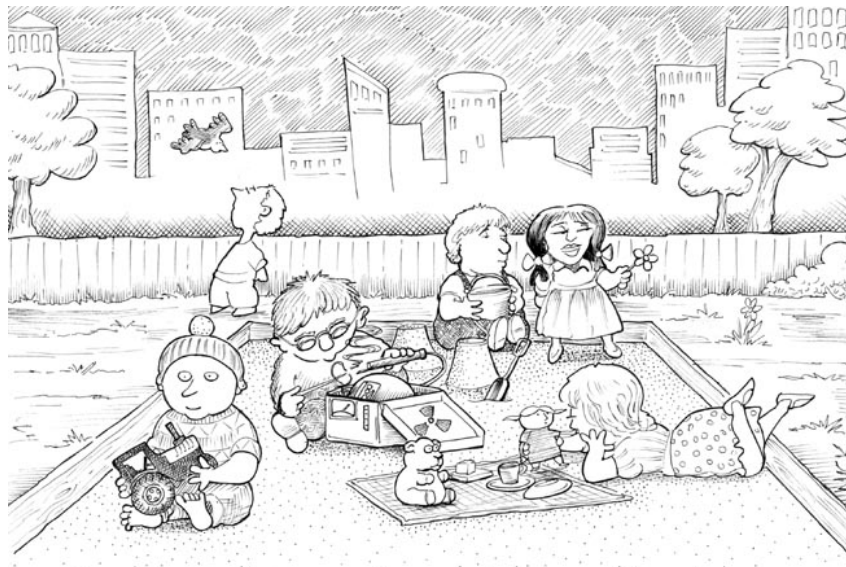
Learn more about Chandra at [www.science.nasa.gov/missions/chandra](http://www.science.nasa.gov/missions/chandra). Take kids on a "Trip to the Land of the Magic Windows" and see the universe in X-rays and other invisible wavelengths of light at [spaceplace.nasa.gov/magic-windows](http://spaceplace.nasa.gov/magic-windows).

*Dr. Weisskopf is project scientist for NASA's Chandra X-ray Observatory. This article was provided by the Jet Propulsion Laboratory, California Institute of Technology, under a contract with the National Aeronautics and Space Administration.*



Caption:

*Composite image of DEM L50, a so-called superbubble found in the Large Magellanic Cloud. X-ray data from Chandra is pink, while optical data is red, green, and blue. Superbubbles are created by winds from massive stars and the shock waves produced when the stars explode as supernovas.*



If all children are natural-born scientists, society might be wise to at least quarantine the subset of these scientist-infants who are the atomic weapons specialists, before they kill us all with their crazy little lunchbox nukes.

*Cartoon by Nick D Kim. Strange-Matter.net Used by permission.*

# Low Cost Hydrogen Line Radio Telescope for £160 (\$250 USD) using the RTL SDR

Peter East

Courtesy British Astronomical Association, RAGazine

David Morgan has written two excellent articles on Measurement and Analysis of the Hydrogen Line<sup>1</sup> and Experiments with a Software Defined Radio Telescope<sup>2</sup>. This was the inspiration to have a go to see what could be achieved with minimum expenditure. Figure 1 shows the resulting schematic and Figure 2 the receiver implementation. Total cost apart from the laptop is about £180. The RF switch isn't really necessary and drops the total cost to £160 (\$250 USD).

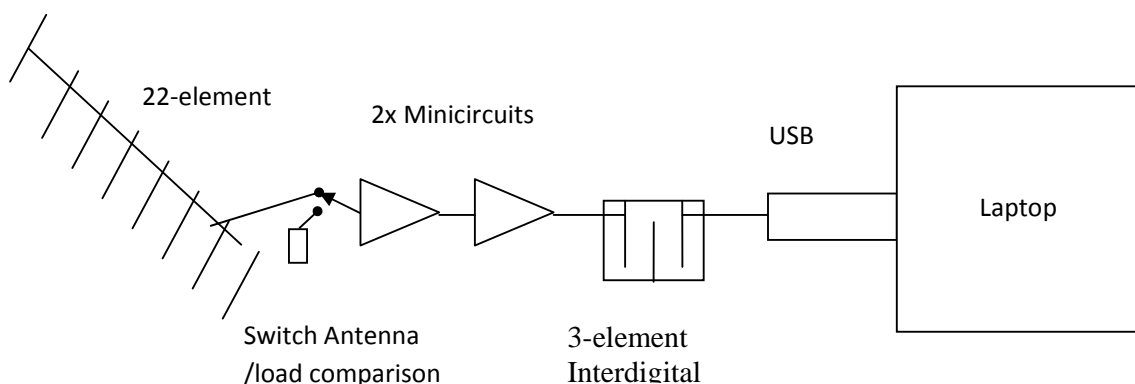


Figure 1. Simple Radio Telescope

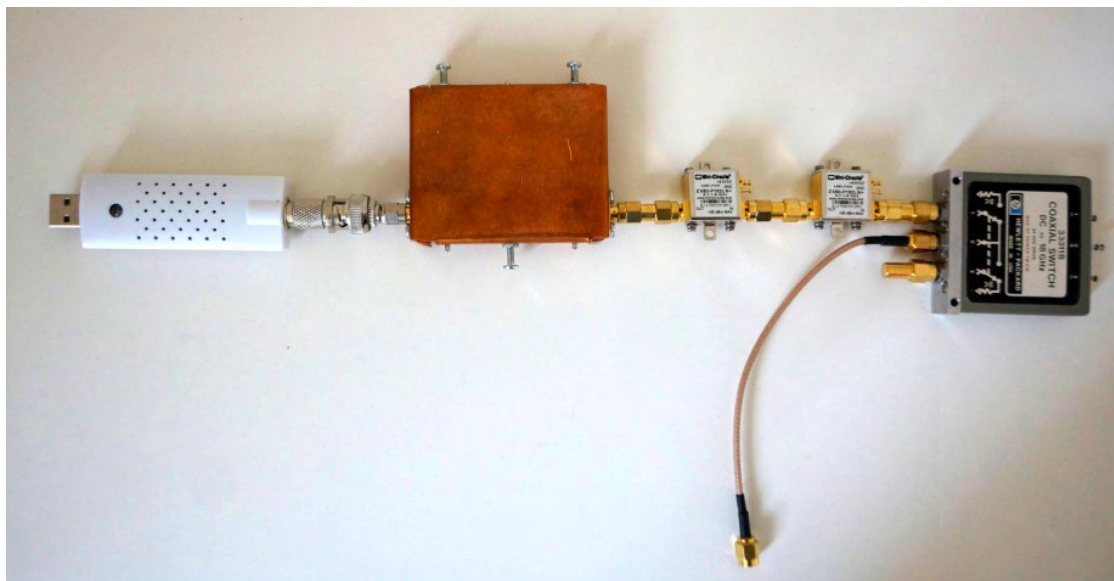


Figure 2. Basic Hydrogen line receiver

## Antenna (£10) (\$16 USD)

The antenna constructed for ease of testing through a bedroom window comprised a 1.5m length of 2cm x 1cm hardwood with 1.6mm brazing rod elements screwed to the hardwood. It was designed using P. McMahon's YagiCAD<sup>3</sup> and based on DL6WU20 file in the software 'Example Models' list. The CAD software allows the design to be re-tuned to 1420MHz – the impedance comes out close to 50ohms with a good

front-to-back ratio. Beamwidth is 26deg and gain about 18dB. Figure 3 shows the antenna with an inset detail of the construction.

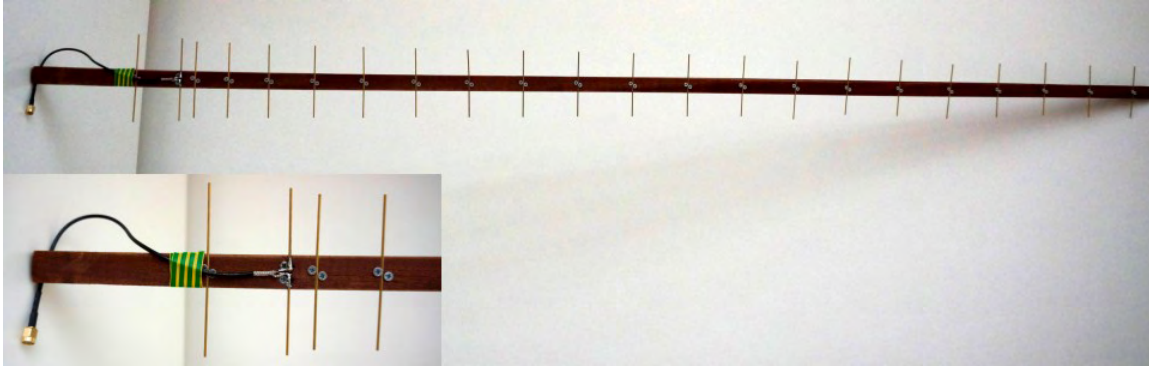


Figure 3. Simple 22-element Yagi

### **Switch (£20) (\$31 USD)**

A single pole 2-way RF switch (Figure 2) provides a reference for comparing and calibrating the signal received from the antenna. In a Dicke switched receiver (<http://www.radiosky.com/dicke.html>) this is toggled at audio rates and integrated in an analogue manner. It is simpler in a digital system to average the received spectrum output first for the signal followed by the reference and carry out the comparison in subsequent file processing in Excel for example. In fact, the switch may not be necessary and the switch loss avoided if the user is prepared to disconnect the antenna and fit a matched load to the receiver input and integrate to obtain the reference measurement.

### **Amplifiers (£110) (\$172 USD)**

These are Minicircuits ZX60-162LN, about 20dB gain and 0.6dB noise figure at 1.4GHz. They each require 4V at 50mA. A reasonably cheap power supply solution was a 20VA, 230V primary, 9V secondary transformer and a Voltage Regulator kit, AC in DC out based on the LM317, both procured via ebay. The Minicircuit's amplifiers cost about £46 each +vat and postage. Lower noise figure (0.25dB) amplifiers are apparently available from S Jewell G4DDK<sup>4</sup> at around £50 for a kit.

### **Filter (£20) (\$31 USD) , Cables and Connectors (£5) (\$8 USD)**

The narrow-band filter was designed using an excellent internet calculator<sup>5</sup> by D. Heatherington WA4DSY and following construction ideas from the Utah ATV Page<sup>6</sup>. I opted for a 5MHz 0.1dB bandwidth 3-element filter. A 0.9mm copper sheet was cut out and bent around sized wooden blocks for the box and lid. 14 gauge tinned copper wire cut for the interdigital elements and SMA connectors for input and output. The input and output connections to the elements needed care to solder as they were about 1mm from the element (box) end as is evident from Figure 4.

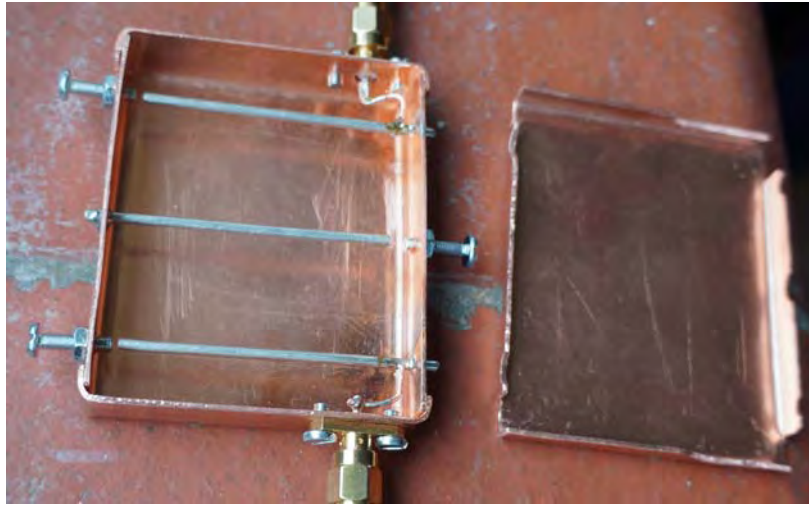


Figure 4. 3-element Narrow Band Interdigital Filter

Tuning is easy for a 3-element first you maximise the centre element then trim the outers using the dongle with SDR# software and monitoring the displayed receiver noise level. By tuning the dongle centre frequency in 1MHz increments either side of 1420MHz the receiver noise amplitude follows the filter characteristic. Performance achieved was 6MHz 0.1dB ripple bandwidth and 16MHz 20dB bandwidth. Initially, this filter tuned 10 MHz but by shortening the centre element (obvious as the tuning screw fell out) success was achieved. Minicircuits offer a filter 100MHz bandpass from 1350 to 1450MHz, but the filter roll-off is too slow to effectively reduce interference. The lid should be soldered or sensibly clamped to ensure stable performance.

## Receiver

**Option A (£157) (\$245 USD):** The FunCube Dongle<sup>7</sup> (FCD) using SpectraVue<sup>8</sup> software. SpectraVue has some useful options for collecting, outputting and processing radio astronomy data. The dongle has 96kHz bandwidth for 192kHz I+Q sampling rate but with the software minimum Fast Fourier Transform (FFT) size of 2048, requires a long observation time with a lot of averaging to achieve an acceptable sensitivity.

SpectraVue provides a useful spectrum display with facilities for FFT averaging.

In the radiometer equation, the temperature sensitivity,  $dT/T = 1/\sqrt{(nbt)}$ , where the FFT bin bandwidth,  $b = 96\text{kHz}/2048 \sim 47\text{Hz}$ , and the FFT data collection period,  $t = 2048/96\text{kHz}$ . Averaging 'n' FFT bins for 100sec, then,  $\sqrt{(nbt)} = 68.5$

(Note:  $bt = 1$  for any single FFT bin for any number of FFT points and clock rate - all the sensitivity benefit comes with the averaging!). In practice, with reasonable observation times, useful, but noisy hydrogen line spectra can be obtained (Figure 5) – the figure shows four overlapping FFT 96kHz spectra covering the frequency range 1419.95 GHz to 1420.2GHz, each covering 96kHz.

This dongle wasn't frequency calibrated and there was known interference from PC's close by. Improved performance was noted when interfering sources were located, screened or switched off.

Data shown is the ratio of the signal from the antenna to the signal (noise) measured when the input is switched to a reference load. Ideally, this removes the receiver gain response and allows temperature calibration – this is demonstrated in the paragraph 'Temperature Calibration' below.



SpectraVue has the capability of outputting files of averaged FFT data and also, raw IQ data in .wav formatted files.

The dongle narrow bandwidth and the software minimum FFT size, makes this a poor receiver choice for hydrogen line work. If the software FFT size were reduced to 32 points (~3kHz bins) this would give an 8-fold reduction in noise, much improving the data quality and receiver sensitivity. To get an equivalent improvement by alternatively extending the observation time, means an increased dwell time from 100sec to more than 1.75hrs.

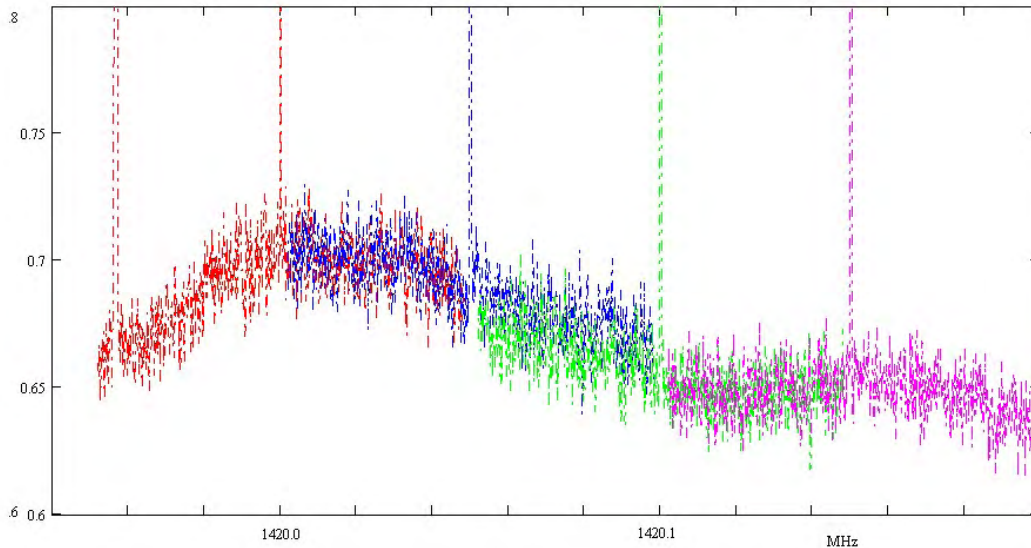


Figure 5 FunCube dongle receiver spectra

**Option B (£15):** The Realtek RTL2832U DVB-TV dongle (RTL) is compatible with SDR# software<sup>9</sup> and needs the Zadig<sup>10</sup> driver for WINDOWS. For Hydrogen line astronomy, the SDR# spectrum displays are not very useful containing only time-constant variable attack and decay on FFT bins. There is, however the facility to record .wav formatted files of I/Q samples at clock rates typically 2.048MHz offering a 2MHz analysis bandwidth suitable for processing off-line.

OsmoCom<sup>11</sup> have produced an 'rtlsdr' library & capture tool. The capture tool produces files (.bin) containing raw IQ data for later analysis and can be viewed using programs such as 'hexdump.exe'. A good description of the rtlsdr tools and data analysis procedure is given in reference (12).

As an alternative, a Java applet<sup>13</sup> and .exe<sup>14</sup> programs have been written to accept OsmoCom captured data to average FFT spectrum results and output text files that can be further processed and viewed in Excel or MathCad.

The Java applet is useful for quick assessment of shortened records, but using browser applet viewers can be very slow to analyse large data blocks. The alternative RAFFT.exe FFT averager program is written in 'C' and is about 30 times faster, averaging data in about the same time as for the data acquisition.

Since both 'signal' and system noise are both zero-mean random noise there is little benefit gained from input data windowing, such as 'Hanning' etc: before computing the FFT spectrum.

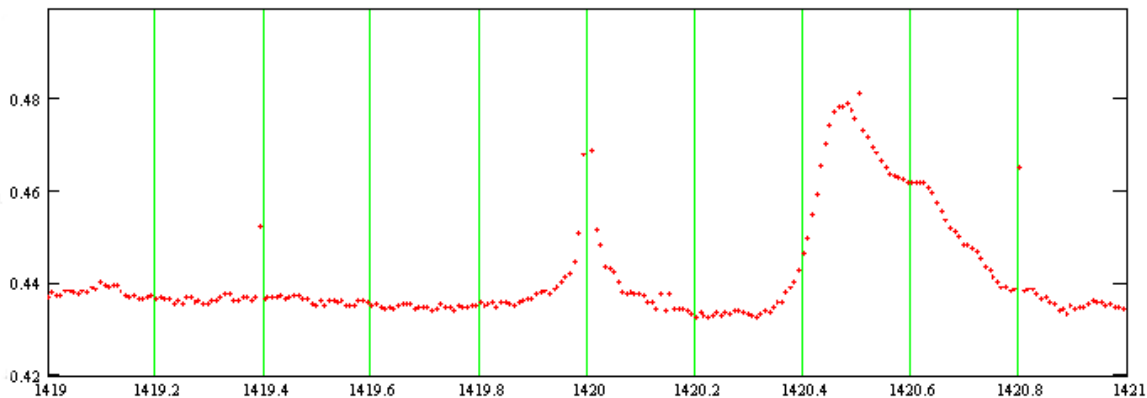


Figure 6 RTL2832U dongle receiver 256-point spectra for Galactic Longitude 145°

Figure 6 shows the Figure 1 receiver response when directed at Galactic Longitude 145° for two 97sec periods. The first period collected data using OsmoCom software rtl\_sdr.exe to output a .bin file with alternate I and Q amplitude data via the antenna. The resulting file was then processed by C-programmed software RAFFT.exe – this inputs the .bin file and carries out almost 400,000 256-point FFTs, and averages these to improve the temperature sensitivity over 600 times.

The second period collects similar data when the receiver input is terminated by a reference load. Figure 6 plots the ratio of the two resulting averaged FFTs processed by the RAFFT.exe program.

The central spike is a dc offset feature and the central broadening is due to dongle VCO noise and it is also noted a few spurious points occur. Again, the receiver has not been frequency calibrated but the hydrogen line components are obvious and compare favourably to that collected by more complex systems<sup>15</sup>. The ordinate is the measured result of taking the ratio of signal record to matched load input record.

The VCO feature can be removed by more receiver gain to better match the input noise signal to the dongle ADC dynamic range. Figure 7 shows improved performance by using a third 20dB gain RF amplifier, increasing the front-end gain to 60dB leaving the dongle gain max at 42dB so that the overall gain exceeds 100dB. Unfortunately pushing the budget up by another £55 (\$86 USD)!

In Figure 7, (below) using two 97sec rtl\_sdr .bin files of antenna and load inputs and RAFFT.exe averaging program, and finally, dividing the resulting text data, the plots show,

*red plot:* Galactic longitude 155°, 0° latitude. - typical hydrogen line plot.

*black plot:* Galactic longitude 145°, +25° latitude, - cold region, but slight bump at 1420.4MHz, zero relative velocity, is easily visible, so checking the RTL dongle frequency calibration.

*blue plot:* Galactic longitude 195°, +10° latitude but directed at the sun, baseline shift shows sun temperature and also hydrogen line ( the antenna beamwidth is 26° so encompasses hydrogen line response at 0°deg galactic latitude). A rough temperature calibration is marked, with the conclusion that there is probably quite a lot of antenna sidelobe thermal noise intercepted.

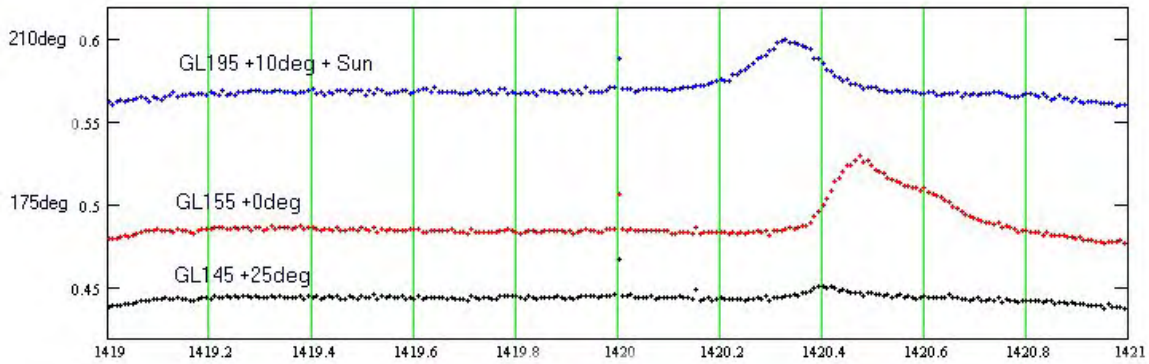


Figure 7 Improved performance with extra RF Gain

### Temperature Calibration

If  $G(f)$  is the power gain of the receiver as a function of frequency,

$b$  is the receiver analysis bandwidth

$T_a$  the wanted signal equivalent temperature

$T_{rx}$  the receiver noise temperature

$T_{ref}$  the reference load temperature

$T_u$  the unwanted noise components (background, sky, sun and ground temperature entering the antenna sidelobes).

$T_c$  the noise generated in the antenna connecting cable.

$k$  is Boltzmann's constant

When switched to the reference input load, the receiver output noise power is

$$P_{ref} = k(T_{ref} + T_{rx})bG(f)$$

When switched to the antenna, the receiver output noise power is

$$P_{sig} = k(T_a + T_u + T_c + T_{rx})bG(f)$$

The ratio  $R$  is simply,

$$R = (T_a + T_u + T_c + T_{rx}) / (T_{ref} + T_{rx})$$

For example, for the RTL dongle,  $T_{ref} = 290^\circ$ ,  $T_{rx} = 75^\circ$  (0.65dB amplifier noise figure, 0.2dB switch loss and 0.2dB connectors).

$T_c = 14^\circ$  for 0.2dB antenna connector and cable loss.

Minimum and maximum ratios  $R$  in Figure 6 are 0.43 and 0.48.

Therefore assuming the ratio 0.43 corresponds to no signal (equivalent ground/cold sky ratio = 3.7dB), but unwanted noise. We can calculate  $T_u$  and  $T_a$  as,

$$T_u = 71^\circ \text{ and } T_a = 18^\circ$$

Atmospheric emission and background noise at this frequency are about 3° each. The efficiency of a Yagi antenna should be better than 90%, so unwanted ground noise should be less than 29°! Let's say it is only 80% efficient, then unwanted ground noise rises to 58° seems to fit the figures

A rough calculation of the signal noise ( $T_a$ ) follows. The antenna beamwidth is 26° so the expected measured signal temperature of a 100° Kelvin hydrogen cloud angular extent 5° x 30° is 17°, which appears about right.

Similarly for the sun, assuming the subtended angle is 0.5deg and equivalent surface temperature 70000deg<sup>16</sup>, the expected equivalent temperature with the antenna pointed at the sun is,  $70000 * 0.25 / 26 / 26 = +26\text{deg}$ .

Since the value for  $T_a$  is reasonable but  $T_u$  is not, there is also the possibility that the antenna copper losses may contribute – 0.5dB loss would account for 35°. There is also possibly some man-made noise being intercepted still.

Signal Integration/Temperature Sensitivity: *The system temperature  $T_{sys}$  from the previous section is  $T_{sys} = T_a + T_u + T_c + T_{rx}$  and with integration, the temperature resolution is  $T_{sys} / \sqrt{nb} = 175 / 68.5 (= 2.5\text{deg})$  for the FunCube dongle and  $175 / 600 (= 0.3\text{deg})$  for the RTL dongle.*

### **Considerations, Limitations and Improvements**

**Interference:** Beware of local interference in the range of the antenna. Personal Computer clock systems radiate significantly in band, local wifi, smartphones, smart tv and ipads etc: should be treated with suspicion. Wrap the dongle in aluminium foil and build a foil-covered box to house the laptop.

**Antenna:** Beamwidth is approximately  $60/d$  degrees, where 'd' is the aperture in wavelengths.

Hydrogen clouds in galactic arms lie within about 5deg latitude; antennas with this beamwidth can be expected to have good temperature detection and moderate angular resolution. Beamwidths greater than this lose out on resolution but more importantly, on detection and temperature measurement loss equivalent to the proportion of beam not illuminated in latitude. Wide beamwidth antennas also tend to allow greater unwanted ground noise into the system through sidelobes. Narrower beamwidths have full temperature sensing ability, can control spillover loss and are also able to resolve temperature variations in latitude and longitude.

**RF Amplifier Noise Figure:** Generally, the lower the better; below 1dB noise figure, however, the benefit of further reducing noise figure may not be very evident for broad-beamwidth antennas whose back and sidelobes illuminate the ground and local warm features, so raising the system temperature. For example, to obtain the same temperature uncertainty, the integration time for the system described with 0.65dB noise figure might only have to be double that required when the pre-amplifier is replaced with a 0.25dB noise figure device.

**Total Receiver Gain:** Gain should be sufficient to ensure that the dongle ADC range is fully utilized. This can be checked on screen using a relevant SDR software package such as SDR#.

Temperature affects amplifier gain and because of the high effective system sensitivity, there may be drift between successive measurements, which can affect temperature calibration accuracy. An optimum solution is for receiver baseplate temperature control. The alternative is to wait for devices to warm up and shield the receiver from the sun and draughts.

**FFT points and clock rate:** The data clock rate defines the dongle operating bandwidth (equal to the clock rate – RTL, and equal to half the clock rate – FCD). The rule is that the more samples processed, the better the frequency resolution. The trade off is time. The product of the bin width (resolution) and the data sample period is 1. The number of sample periods averaged is the integration time required to get a reasonable signal-to-noise ratio. So the better the resolution required the longer the time is needed for the antenna to dwell on a chosen direction. Since the line width of hydrogen is significant, due to velocity variations of gas in the observed cloud there is a sensible limit to the resolution required to infer cloud velocity components.

## ***Conclusions***

It appears that this basic technique using a simple antenna can provide a useful platform for detecting and studying the hydrogen line. It is evident that smaller beamwidth, more efficient antennas would considerably improve the data quality.

Comparing dongles, the broader bandwidth of the Realtek RTL device makes this a better choice.

Comparing SDR software, both FCD and RTL dongles can be used with SDR#, but the software is not well-matched for hydrogen line radio astronomy. FFT averaging of hundreds of thousands of samples is required to achieve the required sensitivity but the SDR# software has only a limited averaging form. SpectraVue does not support the RTL dongle but has a good averaging function although FFT size is too large and very long observation times probably requiring tracking may be necessary unless of course you are blessed with a multi-metre dish.

Both software packages do provide a raw data file output in .wav format that can be processed off-line.

RAFFT.exe provides this function but in its basic form, reverses the spectrum and may slightly corrupt the data by processing the header. The plan is to update RAFFT.exe to operate correctly on .wav files.

More information available at <http://www.y1pwe.co.uk/RAProgs/index.html>

## ***Final Observation***

From an amateurs' point of view, there appears to be an optimum solution for detection and analysis of hydrogen in the arms of our galaxy. The RTL receiver and processing as described, but using an antenna with around 2m aperture (beamwidth of the order of 6deg). This is sufficient for full SNR detection and temperature measurement of galactic hydrogen with moderate angular resolution in both latitude and longitude. The FFT frequency resolution as described does not require antenna tracking and is sufficient to indicate and separate the galactic arms.

Increased demand for better angular resolution requires larger dish apertures. Better frequency resolution requires longer dwell times and therefore accurate tracking of the antenna pointing direction.

## ***References***

1. [http://www.britastro.org/radio/projects/Measurement\\_of\\_Neutral\\_Hydrogen\\_Velocities.pdf](http://www.britastro.org/radio/projects/Measurement_of_Neutral_Hydrogen_Velocities.pdf)
2. [http://www.britastro.org/radio/projects/An\\_SDR\\_Radio\\_Telescope.pdf](http://www.britastro.org/radio/projects/An_SDR_Radio_Telescope.pdf)
3. <http://www.yagicad.com/YagiCAD/YagiCAD.htm>

4. <http://www.g4ddk.com/>
5. <http://www.wa4dsy.net/cgi-bin/idbpf>
6. [http://www.ussc.com/~uarc/utah\\_atv/interdigital1.html](http://www.ussc.com/~uarc/utah_atv/interdigital1.html)
7. <http://www.funcubedongle.com/>
8. <http://www.moetronix.com/spectravue.htm>
9. <http://www.sdrsharp.com/index.php/downloads>
10. <http://rtlsdr.org/softwarewindows>
11. <http://sdr.osmocom.org/trac/wiki/rtl-sdr#>
12. [http://inst.eecs.berkeley.edu/~ee123/fa12/rtl\\_sdr.html](http://inst.eecs.berkeley.edu/~ee123/fa12/rtl_sdr.html)
13. <http://www.y1pwe.co.uk/RAProgs/RadAst.htm>
14. <http://www.y1pwe.co.uk/RAProgs/RAFFT.exe>
15. <http://astro.u-strasbg.fr/~koppen/ISGH5/index.html>
16. Burke BF. Graham-Smith F. "An Introduction to Radio Astronomy (Second Edition)", 2002.

### **Appendix - Post Processing**

Both OsmoCom rtl tools and the FFT averager are run in the command line. The procedure for this is described below.

1. Copy 'Command.com' from C:\WINDOWS\system32\ to your working folder/directory, placed on the Desktop
2. Open 'Command.com' check that it is initialised in your working directory.
3. Type, **doskey** and press the keyboard Return key. This allows the up/down keys to be used to remember earlier commands for ease of editing and repeating..
4. To record data to .bin files, type on the command line... **rtl\_sdr.exe ./capture1.bin -f 1420e6 -s 2048e3 -g 42 -n 200e6**  
-tunes to 1420MHz, samples both I and Q ADC's at 2.048MHz, sets dongle gain at 42dB and records 200million I and 200million Q samples interlaced in the output file. The output file capture1.bin is stored in the current folder
5. To perform and average 256-point FFT spectra.... **RAFFT.exe capture1.bin capture1.txt 256**  
- the output capture1.txt file stored in the current directory can be input to Excel or any math cad program to compare pairs of load and antenna files to view hydrogen line spectrum.

Editor Note- The conversions shown from GBD to US Dollar are as of August 29<sup>th</sup> . To get a current conversion from British Pound to your currency, use this calculator  
[http://www.unitconversion.org/unit\\_converter/currency.html](http://www.unitconversion.org/unit_converter/currency.html).

# The Horn Antenna in Radio Astronomy

By  
Jeff Lichtman

A horn antenna or microwave horn is an antenna that consists of a flaring metal waveguide shaped like a horn to direct radio waves in a beam. Horns are widely used as antennas at UHF and microwave frequencies, above 300 MHz. An advantage of horn antennas is that since they have no [resonant](#) elements, they can operate over a wide range of [frequencies](#), a wide [bandwidth](#).

## Horn History

One of the first horn antennas was constructed in 1897 by Indian radio researcher [Jagadish Chandra Bose](#) in his pioneering experiments with microwaves.<sup>[4][5]</sup> In the 1930s the first experimental research (Southworth and Barrow, 1936) and theoretical analysis (Barrow and Chu, 1939) of horns as antennas was done.<sup>[6]</sup> The development of [radar](#) in World War 2 stimulated horn research to design feed horns for radar antennas. The corrugated horn invented by Kay in 1962 has become widely used as a feed horn for microwave antennas such as [satellite dishes](#) and [radio telescopes](#).<sup>[6]</sup>

## Horn Descriptions

**Pyramidal horn (a, right)** – a horn antenna with the horn in the shape of a four-sided pyramid, with a rectangular cross section.

**Sectoral horn** – A pyramidal horn with only one pair of sides flared and the other pair parallel. It produces a fan-shaped beam, which is narrow in the plane of the flared sides, but wide in the plane of the narrow sides. These types are often used as feed horns for wide search radar antennas.

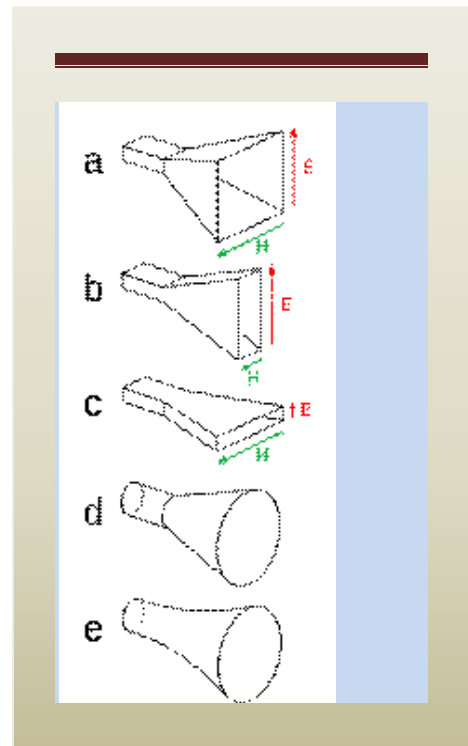
**E-plane horn (b)** – A sectoral horn flared in the direction of the electric or E-field in the waveguide.

**H-plane horn (c)** – A sectoral horn flared in the direction of the magnetic or H-field in the waveguide.

**Conical horn (d)** – A horn in the shape of a cone, with a circular cross section. They are used with cylindrical waveguides.

**Exponential horn (e)** – A horn with curved sides, in which the separation of the sides increases as an exponential function of length. Also called a scalar horn, they can have pyramidal or conical cross sections.

These horns have minimum internal reflections, and almost constant impedance and other characteristics over a wide frequency range. They are used in applications requiring high performance, such as feed horns for communication satellite antennas and radio telescopes.



**Corrugated horn** – A horn with parallel slots or grooves, small compared with a wavelength, covering the inside surface of the horn, transverse to the axis. Corrugated horns have wider bandwidth and smaller sidelobes and cross-polarization, and are widely used as feed horns for satellite dishes and radio telescopes.

**Ridged horn** – A pyramidal horn with ridges or fins attached to the inside of the horn, extending down the center of the sides. The fins lower the cutoff frequency, increasing the antenna's bandwidth.

**Septum horn** – A horn which is divided into several subhorns by metal partitions (septums) inside, attached to opposite walls.

**Aperture-limited horn** – a long narrow horn, long enough so the phase error is a negligible fraction of a wavelength, so it essentially radiates a plane wave. It has an aperture efficiency of 1.0 so it gives the maximum gain and minimum beamwidth for a given aperture size. The gain is not affected by the length but only limited by diffraction at the aperture.[10] Used as feed horns in radio telescopes and other high-resolution antennas.

**The Discovery of Hydrogen Radio emission by Ewen and Purcell**

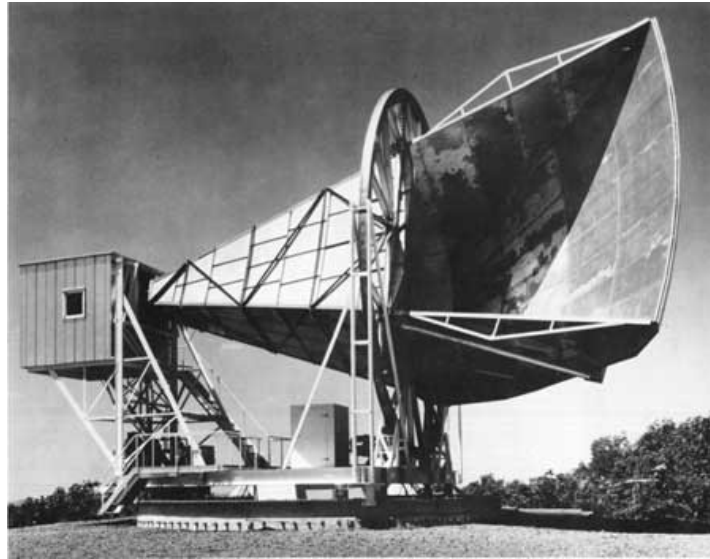
<http://www.nrao.edu/whatisra/images/ewenpurbow.jpg> In 1950, "Doc" Ewen was working 40 hours a week designing and building apparatus for the new cyclotron at Harvard. In addition, during nights and weekends, he was working on completing a doctorate in physics by building a receiver to detect the 21 cm line of neutral hydrogen, supervised by Purcell.

This horn antenna, now displayed in front of the Jansky Lab at NRAO in Green Bank, WV, was used by Harold Ewen and Edward Purcell, then at the Lyman Laboratory of Harvard University, in the first detection of the 21 cm emission from neutral hydrogen in the Milky Way. The emission was first detected on March 25, 1951.

		
<p><b>Original Photo at Harvard</b></p>	<p><b>Actual Horn at NRAO. Green Bank, West Virginia (Friend, Kerry Smith)</b></p>	<p><b>H.I. ("Doc") Ewen pictured with his horn on the occasion of a visit to NRAO-Green Bank May 22, 2001. He had not seen his horn antenna since 1956!</b></p>



Penzias & Wilson (1965, ApJ, 142, 419) showed that the zenith antenna temperature of the Bell Labs horn was 3.5 K higher at 4 GHz than expected—the first detection of the cosmic microwave background radiation.



**Horn Antenna — Holmdel, New Jersey.**

**Horn Antenna, circa 1960.**

**(Photo Credit: Bell Labs)**

---

Period: 1964-1965

Builder: Mr. A. B. Crawford

The Horn Antenna at Bell Telephone Laboratories in Holmdel, New Jersey, was constructed in 1959 to support Project Echo--the National Aeronautics and Space Administration's passive communications satellite project.

The antenna is 50 feet in length with a radiating aperture of 20 x 20 feet and is made of aluminium. The antenna's elevation wheel is 30 feet in diameter and supports the weight of the structure by means of rollers mounted on a base frame. All axial or thrust loads are taken by a large ball bearing at the apex end of the horn. The horn continues through this bearing into the equipment cab. The ability to locate receiver equipment at the apex of the horn, thus eliminating the noise contribution of a connecting line, is an important feature of the antenna. A radiometer for measuring the intensity of radiant energy is found in the equipment cab.

The triangular base frame of the antenna is made from structural steel. It rotates on wheels about a center pintle ball bearing on a track 30 feet in diameter. The track consists of stress-relieved, planed steel plates which are individually adjusted to produce a track flat to about 1/64 inch. The faces of the wheels are cone-shaped to minimize sliding friction. A tangential force of 100 pounds is sufficient to start the antenna in motion.

To permit the antenna beam to be directed to any part of the sky, the antenna is mounted with the axis of the horn horizontal. Rotation about this axis affords tracking in elevation while the entire assembly is rotated about a vertical axis for tracking in the azimuth.

With the exception of the steel base frame, which was made by a local steel company, the antenna was fabricated and assembled by the Holmdel Laboratory shops under the direction of Mr. H. W. Anderson, who also collaborated on the design. Assistance in the design was also given by Messrs. R. O'Regan and S. A. Darby. Construction of the antenna was completed under the direction of Mr. A. B. Crawford from Freehold, New Jersey.

When not in use, the antenna azimuth sprocket drive is disengaged, thus permitting the structure to "weathervane" and seek a position of minimum wind resistance. The antenna was designed to withstand winds of 100 miles per hour and the entire structure weighs 18 tons.

The Horn Antenna combines several ideal characteristics it is extremely broad-band, has calculable aperture efficiency, and the back and sidelobes are so minimal that scarcely any thermal energy is picked up from the ground. Consequently it is an ideal radio telescope for accurate measurements of low levels of weak background radiation.

A plastic clapboarded utility shed 10 x 20 feet, with two windows, a double door and a sheet metal roof, is found next to the Horn Antenna. This structure houses equipment and controls for the Horn Antenna and is included in this nomination.

---

### **Little Big Horn (NRAO GREEN BANK)**



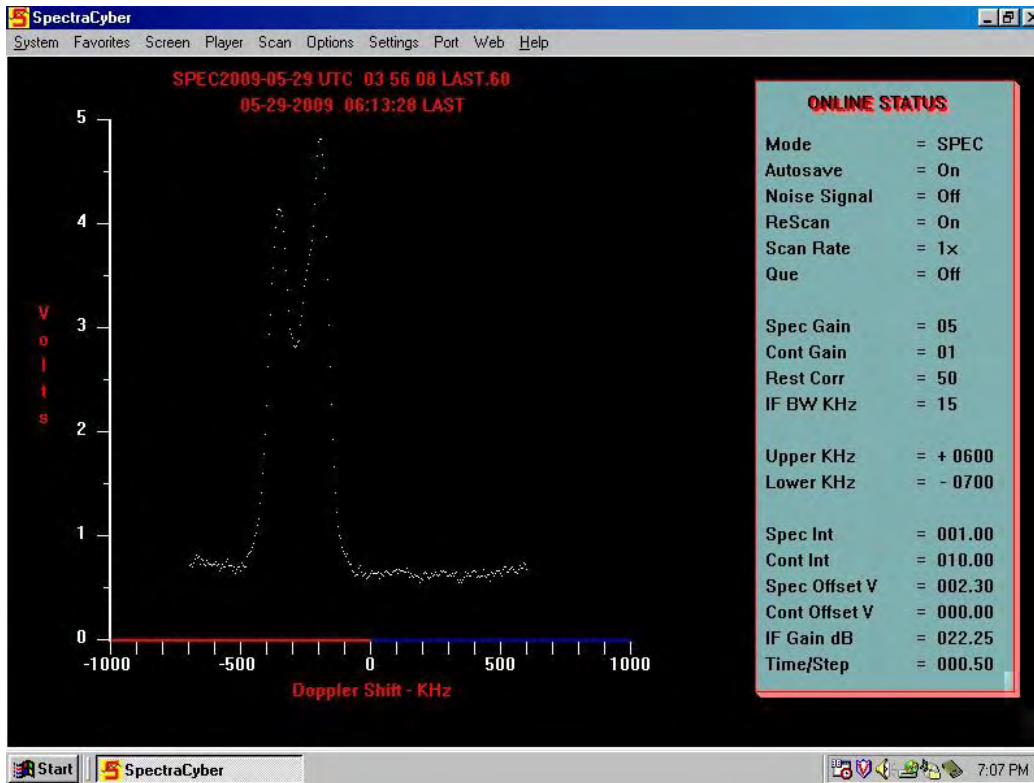
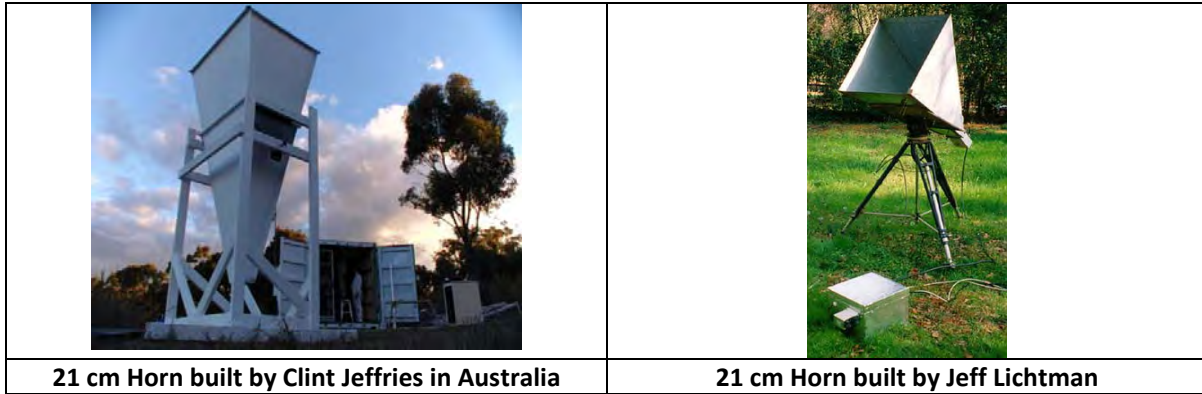
**The Calibration Horn Antenna, also known as "Little Big Horn." First observations were made in October 1959, and absolute flux measurements of Cas A began in March 1960. NRAO/AUI image.**

Some of the early SARA conference attendees had the extreme pleasure of seeing this horn. As the years went by, vegetation and time had taken its toll. The site is located north of the main site. If one passes the motor pool, there is a dirt road via an old cemetery. When you reach the street, turn left and head west till you get to a field, follow the dirt road. **Be careful of critters and poison ivy!**

SARA members, Jim Sky and Jim Carroll actually connected a receiver to the horn. When they removed the termination, they were greeted to a torrent of water that had collected in the horn. Kerry Smith scaled the horn on our first visit and became known as the "Kerryometer" due to the heat of his body. A great calibration Source!

---

Below are some horns built by amateurs



**Red Shifted Hydrogen scan detected by Ryan Lane, using a RAS Spectracyber at the University of North Texas**

---

### **References**

I would like to thank all those who contributed information on the following sites.

<http://search.nrao.edu>

[http://www.cr.nps.gov/history/online\\_books/butowsky5/astro4k.htm](http://www.cr.nps.gov/history/online_books/butowsky5/astro4k.htm)

<http://search.nrao.edu/?q=ewen+purcell&ie=&oe=>

[http://en.wikipedia.org/wiki/Horn\\_Antenna](http://en.wikipedia.org/wiki/Horn_Antenna)

Text is available under the [Creative Commons Attribution-ShareAlike License](#); additional terms may apply. By using this site, you agree to the [Terms of Use](#) and [Privacy Policy](#).

Wikipedia® is a registered trademark of the [Wikimedia Foundation, Inc.](#), a non-profit organization.

## High Noise Levels — Possible Solutions

by Richard Flagg

Reprinted from *The Jove Bulletin*, June 2013

In the June 2013 QST magazine (a ham radio publication) there is an interesting article by Robert Wilson titled "The Great RFI Hunt". RFI means radio frequency interference. Wilson goes to great lengths to track down interference to his ham radio receiver. While he writes about interference in the amateur radio bands his findings may be helpful to Jove observers listening on 20.1 MHz and also those operating spectrographs.

To summarize his findings:

1. A Linksys WRT54GS router was a source of much interference. The router recommended for RF sensitive environments is the Netgear WNDR4000 (N750). <http://www.netgear.com/>
2. Instead of using unshielded CAT5 Ethernet cables between router and computer he suggests using CAT6 shielded twisted pair cables with a type 31 and type 61 Fair-Rite toroid on each end of the cable. (<http://www.fair-rite.com/newfair/index.htm>)
3. A replacement computer power supply (Silencer 760 watt) from PC Power ([www.pcpower.com](http://www.pcpower.com)) produced far less RFI than the original supply in his computer

## Twisted Humour

Two engineering students were biking across a university campus when one said, "Where did you get such a great bike?" The second engineer replied, "Well, I was walking along yesterday, minding my own business, when a beautiful woman rode up on this bike, threw it to the ground, took off all her clothes and said, "Take what you want." The first engineer nodded approvingly and said, "Good choice: The clothes probably wouldn't have fit you anyway."



# SID Monitoring in Slovakia

Courtesy of ISWI Newsletter

*I. Dorotovič, National ISWI Coordinator; SCO Hurbanovo, [ivan.dorotovic@suh.sk](mailto:ivan.dorotovic@suh.sk)  
T. Pintér, SCO Hurbanovo, [teodor.pinter@suh.sk](mailto:teodor.pinter@suh.sk)*

## Abstract

This contribution presents the Slovak SID monitoring network. Two SuperSID monitors were kindly provided by the Stanford University in the frame of the ISWI SID monitor network, one is installed in the Slovak Central Observatory in Hurbanovo and other is being installed in the Astronomical Observatory in Rimavska Sobota. Moreover, there are several SID monitors constructed by R. Slošiar (Bojnice) and J. Karlovsky (Hlohovec) operated in Bojnice, Hlohovec, Hurbanovo, Partizánske, and Roztoky. Results on registration of solar flares are presented as well.

## 1. INTRODUCTION

Introduction and detailed information to SID (Sudden Ionospheric Disturbances) Monitor can be found e.g. at Stanford Solar Center (<http://solar-center.stanford.edu/SID/sidmonitor/>) or at AAVSO website (<http://www.aavso.org/solar-sids>).

## 2. SID MONITORING NETWORK IN SLOVAKIA

SID Monitoring is an indirect detection of solar flares. J. Karlovský (Hlohovec) a R. Slošiar (Bojnice) constructed their own SID monitors, which are installed in Bojnice and in the Astronomical Observatories Hlohovec, Hurbanovo, and Partizánske. J. Karlovský constructed also one SuperSID monitor.



*SID monitoring – real-time data:*

- **Bojnice** <http://195.160.182.241/page/rudy/>
- **Hlohovec** <http://karlovsky.info/sid/temphtml.htm>
- **Hurbanovo** <http://www.suh.sk/skypipedata.htm>
- **Partizánske** <http://195.160.182.241/page/>
- **Roztoky** no real-time data available, yet.

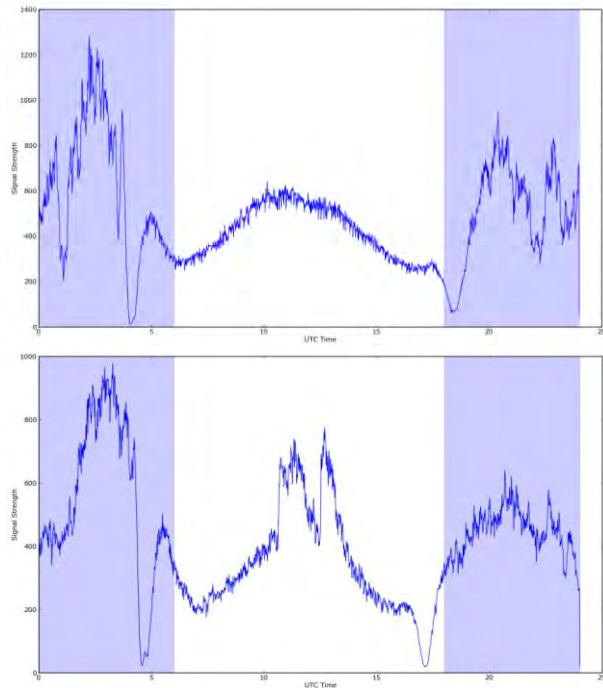


*SuperSID monitoring:*

In the Slovak Central Observatory (SCO) Hurbanovo are installed also other SID monitors and one SuperSID monitor (this one in the frame of the ISWI program) – real-time data will be available soon. Another SuperSID monitor is being installed in the Astronomical Observatory in Rimavská Sobota.



*Figure 1. Antenna of the SuperSID monitor in Hurbanovo (top panel) and in Rimavská Sobota (bottom panel).*



5 October 2011, HWU 20.9 kHz

Figure 2. Typical ionospheric behaviour – a day without solar flare activity (top panel) versus solar flare activity day behaviour – 5 October 2011 (bottom panel).

### 3. ANTENNAS AND SID MONITORS



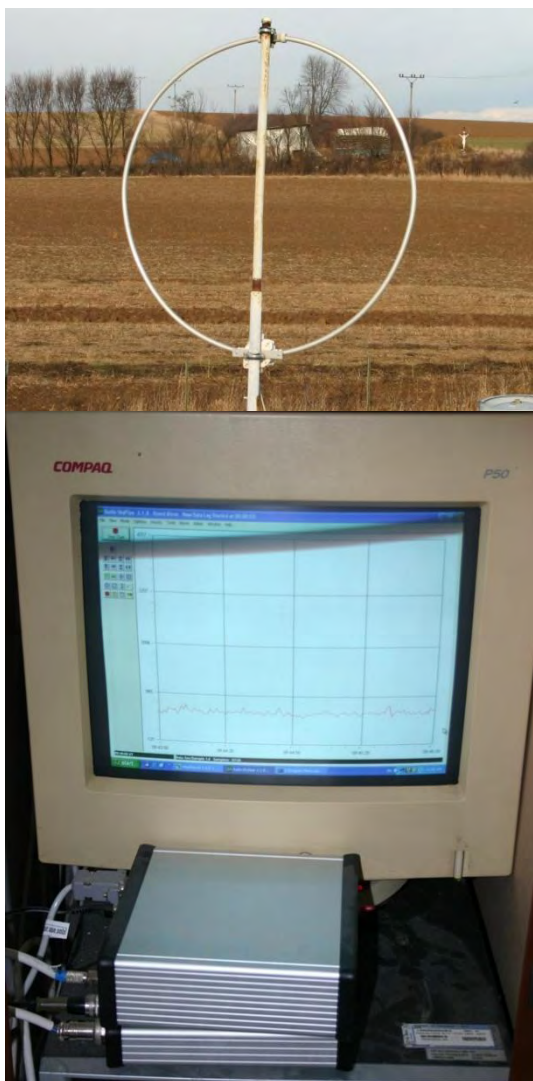
Hlohovec



Bojnice



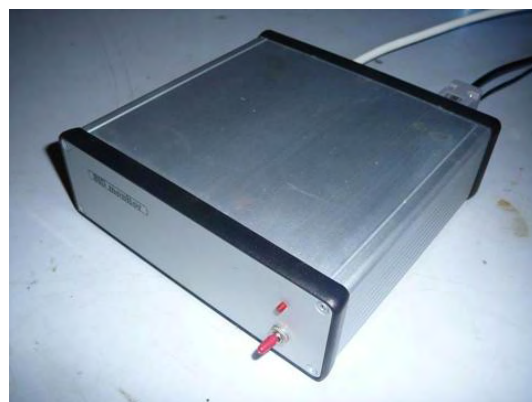
Hurbanovo



*Partizánske*

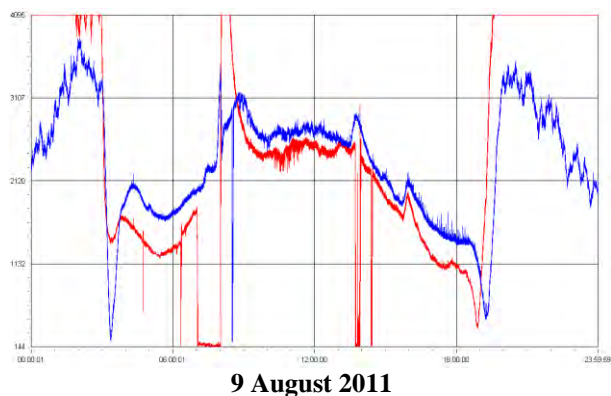


*Roztoky*

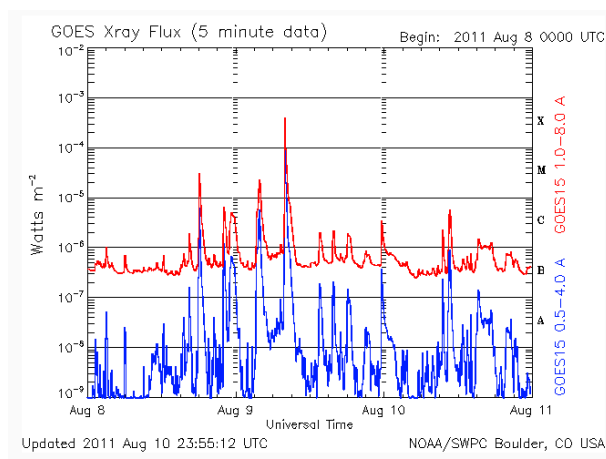


*Figure 3. Antennas and SID monitors at individual observing sites.*

#### 4. DETECTION OF SOLAR FLARES



**9 August 2011**



*GOES X-ray data.*

*Figure 4. Record of the SID Monitor – SCO Hurbanovo (left panel) and the GOES X-ray data for comparison (right panel).*

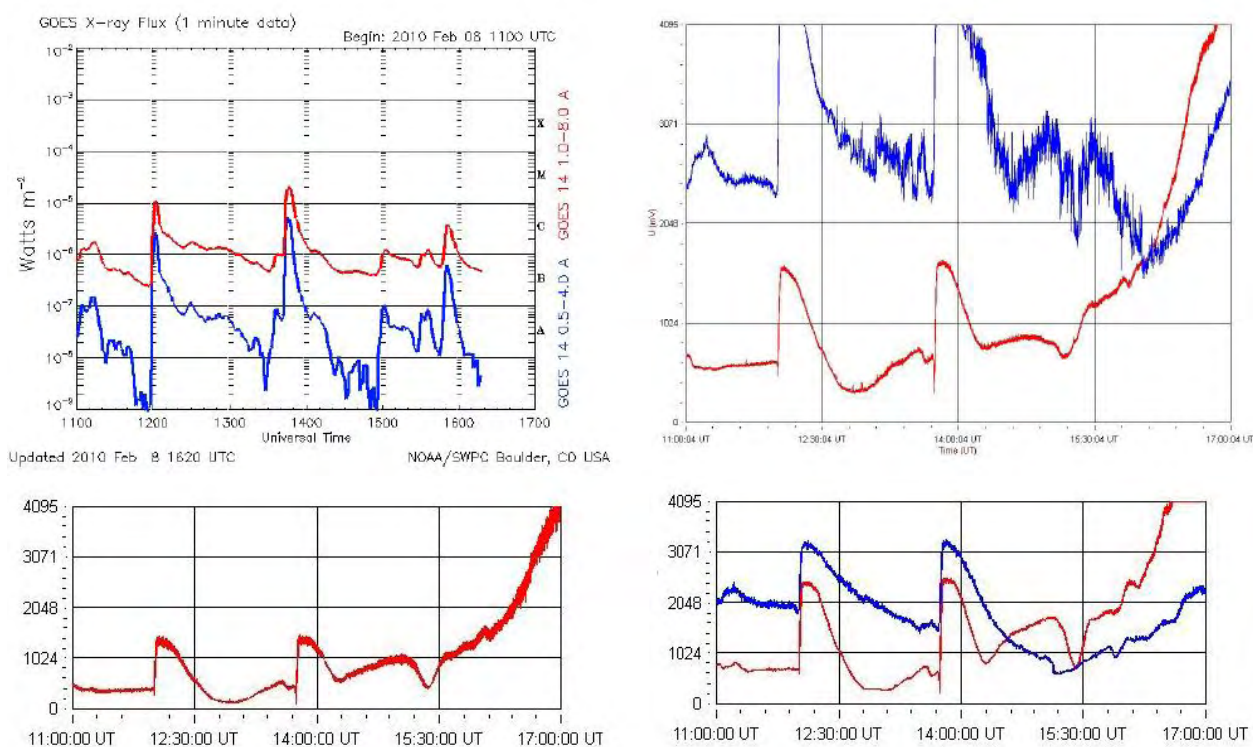


Figure 5. Three SID monitors from observatories Hlohovec (top-right), Partizánske (bottom-left) and Bojnice (bottom-right) detected the M class solar flare on 8 February 2010; GOES X-ray data for comparison (top-left).

## 5. DETECTION OF GAMMA RAY BURSTS

SID monitor is sensitive enough to detect such faint ionospheric events like Gamma Ray Bursts (GRBs). SID monitor network can eliminate noise coming from different sources mostly relatively close to SIDmonitor antenna, like close factories, electronics devices or for example neon light tubes. Three SID monitors (Partizánske, Hlohovec, Rudy BASE Bojnice) detected small disturbance in the middle of a solar flare ionospheric response on 12 February 2010. The detection shown in Fig. 6. clearly shows how important is SID monitor network and how sensitive it can be.

We already have four SID monitor sites in Slovakia, other SID monitors are installed in the Czech Republic (Brno, Ondřejov). Detailed information on detection of GRBs was published by Hudec et al. (2010) and Slošiar et al. (2011). Another example of GRB detection can be found in Kocka et al. (2011).

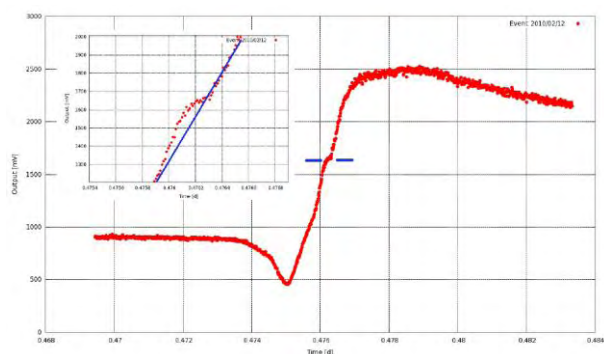


Figure 6. Detection of Gamma Ray Burst (GRB) on 12 February 2010.

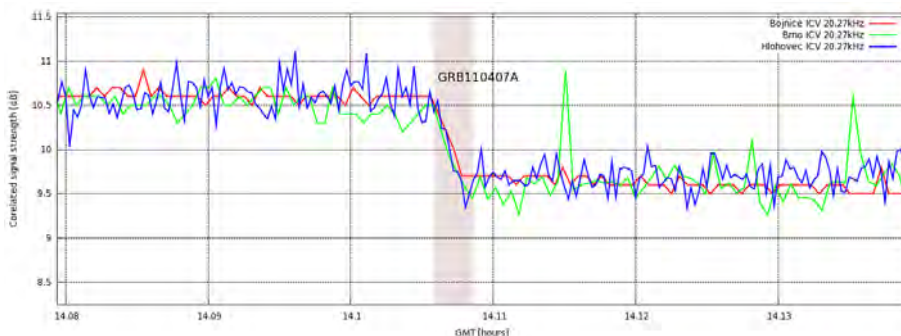


Figure 7. Detection of GRB published by Kocka et al. (2011).



## Acknowledgements

The authors are grateful to the Stanford Solar Center and the Society of Amateur Radio Astronomers (SARA) for providing two SuperSID monitors for installation in Slovakia.

## REFERENCES

- Hudec, R., Spurný, M., Křížek, M., Pata, P., Slošiar, R., Řeřábek, M.; Klima, M.: 2010, Detection of GRBs and OTs by All-Sky Optical and SID Monitors, *Advances in Astronomy*, article id. 428943, 10.1155/2010/428943.
- Slošiar, R., Hudec, R., Kocka, M., Marko, R., Zaťko, M.: 2011, Indirect detections and analyses of GRBs by ionospheric response: toward a SID-monitor network, *GAMMA RAY BURSTS 2010*. AIP Conference Proceedings, Volume 1358, pp. 393-396.
- Kocka, M.; Slošiar, R.; Karlovský, V.; Marko, R.; Karlovský, J.: 2011, GRB 110407A: VLF observations on 20.27kHz., *GRB Coordinates Network, Circular Service*, 11914.

## Spectrum Ecology & Conservation

---

By Charles Osborne

Talk of ecology usually conjures up visions of quiet forests far from signs of man's progress into outer space. But on desolate plateaus in Peru, mountaintops above the clouds in Hawaii, and quiet mountain valley's in forests optical and radio telescopes hide. Hiding from those very signs of progress that they represent, city lights and radio signals.

In America and Latvia... foes once peering at each other in quiet vigilance.



Now these giant antennas are tuned to the faintest of signals from our Milky Way and beyond, various atoms and molecules, usually of hydrogen emitting a faint signal at 1420.405 MHz. Yet like listening for a heartbeat amid a room filled with a hundred talking people, it is made difficult by the confusion of modern life: cell phones, TV stations, and satellites, all competing for our attention as well.

This is the technology side of ecology. For the average person, the connection between complaining about a cell phone being noisy or not working, and the cellular towers they fight to keep out of their neighborhood is a mystery. But the landscape is becoming dotted with the towers like an oil field full of derricks. Each tower bringing with it dozens of new transmitters.

With each new signal, the chance of an unforeseen reaction with a nearby transmitter increases. Every rusty fence joint and corroded tower bolt becomes a diode multiplying, mixing, and adding permutations of the original signals to create new ones on frequencies where they shouldn't be. A good analogy is mixing too many prescription medications. The results become more unpredictable as the complexity rises.

### ***History***

Radio astronomy is a young science, born in the 1930's. By the late '50's many of the world's great radio astronomy observatories were under construction or being planned.

In a cruel irony, at the same time radio dishes were being made more sensitive, satellites were beginning to dot the skies with their own competing signals raining Earthward on similar frequencies. A race began to understand the cosmos before the measurements became too contaminated to yield good data.

### ***Protection***

Seeing that the spectrum was a fixed resource, radio astronomy began lobbying regulating bodies (like the World Radio Conference, International Telecommunications Union, or Federal Communications Commission)

for protection around molecular emission frequencies as they found them. These became the “green spaces” where all transmit activity was illegal worldwide. International consensus is hard to achieve. Often decades passed before the myriad governing bodies offered up rules they all agreed upon. Usually this was but a tiny piece of the original need. Or now superceded by new information, submitted to governing bodies too beaten down to win the hard fight over new spectrum.

## ***Spectrum Ecology***

But as spectrum went from wide-open spaces, to hotly fought for property, many were not found to be valuable for radio astronomy until too late. With \$Billions invested, commercial concerns would fight fiercely to keep “their” frequencies. Often populating a frequency with thousands of users was the secret to making it unpalatable for radioastronomy to fight for anymore. This effectively polluted the frequencies from being mined for their weak galactic noise.

As the size and age estimates of the Universe increased, marker frequencies that were once comfortably protected, were found to be Doppler shifted outside their assignments, lower in frequency, till they merged into the high power mire of cell phones, satellites, and television. Even in the outback of Australia, the Atacama plateau in Peru, Mona Kea in Hawaii, the Plains of St. Augustine in the American southwest, radio telescopes still couldn’t escape the satellites and encroaching people.

So they pick their way thru damaged data, shutting down, while the farmer microwaves his dinner, even in the Outback of Australia. Piecing together years of hopefully clean data, as small segments of observing time.

Imagine being an optical astronomer who needs a 20 hour time exposure of a nebula to soak up enough faint photons to record the details needed. That would mean multiple nights, carefully matched and recorded. But what if airplanes criss-crossed the sky over the optical telescope for all by two hours per night? Now it would take ten (clear) nights. Look carefully at any wide field long exposure optical photo poster. You’ll be surprised at the number of satellites crossing that small piece of sky, like colored scratches on the negative.

As a radio astronomer, even if these satellites were not on our frequency, they still reflect the signals leaking from the ground illuminating them with a glow of thousands of transmitters. Like passive radar they reflect the signals back from their metal surfaces and antennas.

Most don’t realize that hidden below a comfortable threshold signals widen out to encompass frequencies well beyond their “assignments”. Below some level, be it –60 dB or 1 part per million, things are ignored and called unmeasurable. But that’s just an arbitrary number, a matter of convenience and economy.

They say that all the energy collected by all the radio telescopes on Earth, amounts to barely the energy of a snowflake hitting the ground. Yet from these miniscule signals come detailed pictures of the life and death of stars, perhaps even a clue to Earth’s near and long term fate as our Sun ages. How can huge interference signals be called unmeasurable in that comparison.

## ***Good Neighbors***

For many years the governing bodies used a good neighbor policy, where sensitive frequencies were protected by placing adjacent frequency assignments with minimally noisy neighbors. But as spectrum pressures rose, it became harder to find quiet neighbors for radio astronomy. In some circles it was even assumed that technology would come to the rescue by creating new ways to deal with spectral pollution. This is much like allowing a waterway to be polluted, while assuming that adequate water filter technology is available to protect the consumer’s health from their drinking contaminated water.

## ***Back in Time***

Like a hiker, dreaming of what a vast wilderness might have been like to explore 300 years ago, radio astronomers daydream of taking their technology back in time to before: microwave ovens, cell phones, satellites, before radio, before electricity. If they could do their measurements against a velvety black sky and total silence, pierced only by Jupiter's crackling storms, the occasional solar flares, and lightning storms hundreds of miles distant. What welcome clarity there would be.

Most can see the analogies between spectrum ecology and clean Earth ecology. Both fight a tough battle as a huge majority of users selfishly chose to push hard to explain concerns aside. Their eyes glaze over at talk of parts per billion or -200 dBm signals.

Why keep the cover on our new 2GHz PC? I don't see the electrons leaking out.

Comparing it to optical astronomy amid gasoline stations so bright at night that we have to wear sunglasses to pump gas. Million watt TV stations pumping out digital TV while their audience is watching satellite TV.

What they can't see, smell, feel, or buy, must not be real, must not be hurting anyone. So spectrum, like clean air and water, becomes a nebulous quantity, hardly worth a fight. Let's hope it never gets that bad. Education is the answer. It's a complex world we live in. But fewer and fewer people understand how all this technology actually works. Fewer still understand how difficult it is to make all the technology work flawlessly together. They just are users (or perhaps addicts is a better phrase) to technology and convenience.

Like a little mercury or arsenic, a few Rads of radiation, and some ultraviolet light, all creeping up on us, as just a little more, day by day, doesn't seem to be hurting anything. Till it's too late to envision a world without such pollution in our lifetimes. There may be answers hidden to questions we have yet to envision. So encourage low radiation devices and dark skies at as many frequencies as practical.



Coordinates: 57.554295, 21.857214

### **Irbene Radio Astronomy Center** Latvia

The world's eighth-largest radio telescope can be found in [Kurzeme](#), not very far from the seaside between [Kolka](#) and [Ventspils](#). Even today, the massive dish of the radio telescope, used during the Cold War years by the Soviet military to spy on Western adversaries, towers above the pine summits. Now, it is a place where Latvian scientists explore stars and listen to the sounds of the universe.

<http://www.latvia.travel/en/irbene-radio-astronomy-center>

# Applying and Measuring Ferrite Beads

Whitham D. Reeve and Tom Hagen

## Part I ~ Ferrite Bead Properties and Test Fixtures

### I-1. Introduction

This article describes in Part I ferrite beads and their applications and simple test fixtures that can be used to measure ferrite bead electrical properties. In Part II we describe the measurement results for a number of different ferrite beads. Part II will be published in the next issue of *Radio Astronomy*. Our test fixtures are a compromise to accommodate a range of clamshell beads but they are adequate for our purposes, which are to obtain reasonably good measurements comparable to manufacturer's data and to measure unidentified beads that have unknown characteristics.

Ferrite beads are used to reduce conducted noise on cables and wires. One or more beads are slipped or clamped over a cable, which forms an RF choke with low impedance at lower frequencies and high impedance at higher frequencies. Ferrite is a ceramic material made from powdered iron oxide plus other metal oxides such as manganese, zinc, copper and nickel in various combinations. For ferrite beads, the material is formed into a hollow cylindrical core and cooked (figure 1). The resulting core material is easily magnetized and demagnetized and is called a *soft ferrite* for this reason. However, ferrite material is mechanically rigid and brittle and can chip and break if mishandled. Many ferrites are electrically non-conductive. In these ferrites eddy currents do not flow in the material thus making them suitable for use at radio frequencies in transformers, inductors, baluns and loopstick antennas.



Figure 1 ~ Ferrite beads used for noise suppression. A solid bead (upper-middle) is shown surrounded by clamshell beads. The clamshell bead is split into two identical pieces and held together by a plastic housing with clasps. The mating surfaces of the clamshell bead are very smooth so that when they are clamped together there is negligible air gap. Ferrite beads are available in many lengths and inside and outside dimensions and different material mixes. Beads with a rectangular slot are available for flat cables.

When a ferrite core is placed around a wire or cable, the ferrite introduces impedance that varies with frequency. Some writers say ferrite beads are non-resonant. In fact, they are resonant to some degree (as shown later) but they have low Q. Depending on the frequency the impedance may be primarily resistive, inductive or capacitive. The core has little effect at lower frequencies including powerline frequencies of 50 and 60 Hz and all reasonable harmonics. However, depending on the material beads can be quite inductive and lossy above 1 MHz and can be used to reject or absorb RF noise.

Although ferrites are available in many shapes, this article is concerned with only two very common types, the solid bead and clamshell bead. The solid bead generally is placed before the cable is terminated whereas the clamshell bead can be placed before or after. The clamshell bead, also called snap-on bead, clamp bead and split bead, is longitudinally split into two identical pieces that, when placed on the cable, are closely aligned with each other and tightly clamped. A plastic housing, or clamshell, designed for this purpose is provided with the bead. The performance of both solid and clamshell beads of the same materials and dimensions is the same unless the housing of the clamshell bead is damaged and allows physical misalignment.

## I-2. Ferrite Bead Applications

Ferrite beads are found on all cable types including USB cables, serial port cables and ac adapter power supply cables (figure 3). They also are placed on coaxial cables to form so-called *choke* baluns (figure 4). A choke balun can be used to reduce noise currents on the cable and, if placed at the point where the cable connects to a balanced antenna such as a dipole, the beads transform the balanced antenna currents to unbalanced coaxial cable currents.

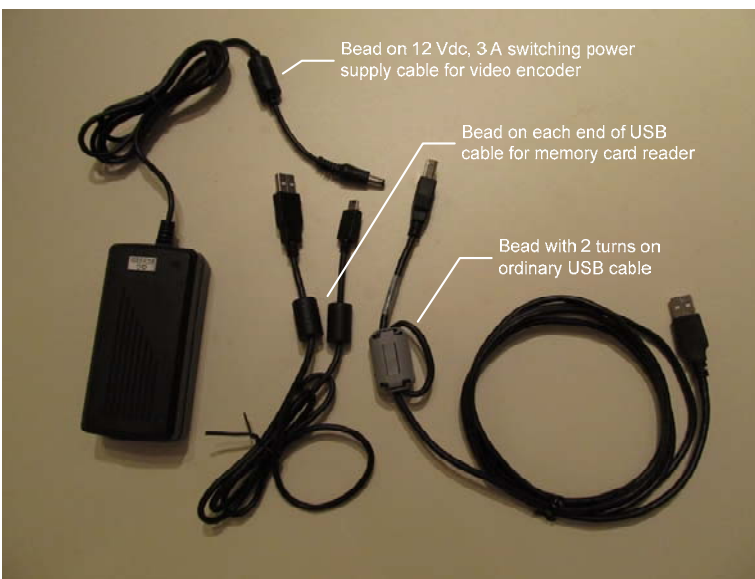


Figure 3 (above) ~ Common applications for ferrite beads include all types of power and signal interface cables.

Figure 4 (right) ~ A choke balun is made by slipping several ferrite beads over a coaxial cable. This image shows five solid beads on LMR-400 cable that have been covered with heatshrink tubing.



When a bead is placed on a cable, the combination is equivalent to a 1-turn or 1-winding coil. The inductive reactance of a coil is proportional to the square of the number of turns (doubling the turns quadruples the reactance). Each pass of the cable through the core is counted as one turn. Beads used with larger sizes of coaxial cable have enough room for only one pass, but multiple turns of a small coaxial cable, such as RG-174/U, can be wrapped around the core (figure 4). However, increasing the number of turns also increases the winding capacitance, which shifts the point of maximum impedance to a lower frequency. Testing should be performed to verify that this is not detrimental to the application.



Figure 4 ~ Clamshell ferrite bead with four windings of RG-174/U coaxial cable. The bead is a very common TDK p/n ZCAT-2035-0930 and has a 9 mm inside diameter.

The most widely available clamshell beads have a 6, 7, 9, 10 or 12 mm inside diameters. A table is provided for quick reference showing common coaxial cable types that may be used with each bead size (table 1). The core inside diameter should never be smaller than the coaxial cable maximum outside diameter or else the cable will be crushed when the core is snapped closed.

Table 1 ~ Cross-reference for core inside diameters and common coaxial cable types with ordinary jackets. The combinations shown accommodate one winding. Note: Most manufacturers supply cables with different outer jackets and shielding options to meet various service requirements (for example, plenum rating or double-shielding), and the outside diameter of these cables may vary from that shown here. (ID: inside diameter). Cable groups are designations used by connector manufacturers to indicate similar dimensions.

Cable types (basic designation)	Bead ID mm (inch)	Cable group	Remarks
RG-58, RG-142, RG-174, RG-316, LMR-100, LMR-195, LMR-200	6 (0.236)	B, C	RG-174, RG-316 and LMR-100 may be used with 3 mm ID
RG-59, RG-62, RG-8X, LMR-240	7 (0.275)	D, X	Includes some versions of RG-6
RG-6	9 (0.354)		Includes quad-shielded RG-6
RG-6	10 (0.393)		
RG-8, RG-213, RG-11, LMR-400	12 (0.472)	E, F, I	

A single ferrite bead may not provide the necessary noise suppression of common-mode RFI currents. Bead inductance theoretically is proportional to its length, so impedance can be increased by using more beads on a given cable. It may be found that four or five, or more beads are needed. The beads should be placed as close together as possible. Spacing is limited by the plastic shells on clamshell types or bends in the cable but solid beads can be stacked in contact with each other on straight cable sections. A cable with many beads on it can become quite heavy and may need special mechanical support to prevent damage to the cable or its connectors.

Where noise is coupled to the cable by conduction, the ferrite bead should be located at the end of the cable closest to the noise source. For example, if beads are used to reduce conducted noise from a switch-mode power supply, they should be placed as close to the power supply as possible. However, if the noise is coupled by other means, the bead should be located as close as possible to the susceptible equipment. The inside diameter of the core should match as close as possible the outside diameter of the cable to provide a close fit. If more than one turn of cable is placed on a core, the windings should be wrapped tightly around the core. However, care needs to be taken with coaxial cable to prevent its deformation and with insulated or coated wire to prevent damage.

A ferrite bead's ability to suppress noise currents in a cable is related to the core temperature and net value of direct current (dc) flowing in the conductors. Significant temperature increases or decreases from normal room temperatures tend to reduce the impedance of a ferrite bead. However, for ordinary low-power indoor applications any changes in bead characteristics are small. Where a ferrite bead is used on a cable that carries dc, if both the feed and return conductors pass through the core, the net dc will be zero and it will not affect the characteristics of the bead; otherwise, the noise suppression capabilities could be reduced. It should be noted that if the return path of the dc circuit is bonded to ground at both ends, then not all of the return path current will flow through the ferrite core, leaving a possibly detrimental unbalanced dc current flow. Additional discussions of temperature and dc effects are beyond the scope of this article but may be found in **References and Further Reading**.

### I-3. Noise Suppression

Ferrite beads suppress higher frequency common-mode currents in a cable. Common-mode currents are currents on the separate cable conductors that flow in the same direction in contrast to signal currents that are differential-mode (also called transverse-mode or normal-mode) and flow in the opposite direction (figure 5). Common-mode currents can be coupled by conduction into the cable from connected equipment but often are coupled by inductive and capacitive means or by electromagnetic radiation into the cable from the surrounding environment. Ferrite beads are very lossy to common-mode currents but in principle are not lossy to the differential-mode signal currents; differential currents are discussed later. It should be remembered that ferrite beads are not designed to reduce noise that is received by an antenna and coupled along with the desired signals into the coaxial cable transmission line as differential-mode currents.

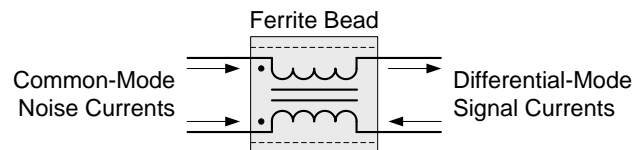


Figure 5 ~ Conceptual diagram of common-mode and differential-mode currents. The magnetic fields setup by the common-mode currents reinforce each other leading to high losses, whereas the fields setup by the differential-mode currents cancel each other out and the currents are not affected.

At lower frequencies in the usable range, the ferrite bead is mostly inductive and rejects (or blocks) common-mode currents because of its inductive reactance. As frequency is increased the impedance is more resistive and the bead absorbs the currents, dissipating them as heat. A ferrite bead can be represented by a simple equivalent circuit consisting of inductance, resistance and capacitance (figure 6). Referring to the circuit,  $R_{\text{bead}}$  and  $L_{\text{bead}}$  are the dc series resistance and effective inductance and  $C_{\text{par}}$  and  $R_{\text{par}}$  are the parallel parasitic capacitance and resistance of the bead. At low frequencies, the parasitic capacitance  $C_{\text{par}}$  acts as an open circuit and  $L_{\text{bead}}$  as a short circuit, leaving only  $R_{\text{bead}}$  in the circuit. As the frequency increases, the impedance of  $L_{\text{bead}}$  initially increases linearly while the impedance of  $C_{\text{par}}$  decreases. The rising slope at the lower frequencies is mostly determined by the inductance of  $L_{\text{bead}}$ , but eventually the impedance of  $C_{\text{par}}$  begins to dominate and the bead's impedance starts to decrease. The falling slope is determined by  $C_{\text{par}}$ .  $R_{\text{par}}$  works to reduce the Q of the bead. These characteristics result in an impedance plot that has inductive, resistive and capacitive regions (figure 7). For more detailed technical explanations and circuit theory, see **References and Further Reading** at the end of this article.



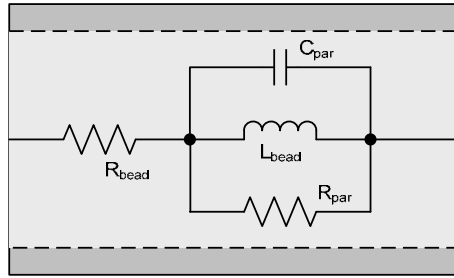


Figure 6 ~ Simplified ferrite bead equivalent circuit. This circuit fairly represents a ferrite bead in isolation. In practical applications, the bead's environment may introduce additional components in complicated arrangements.

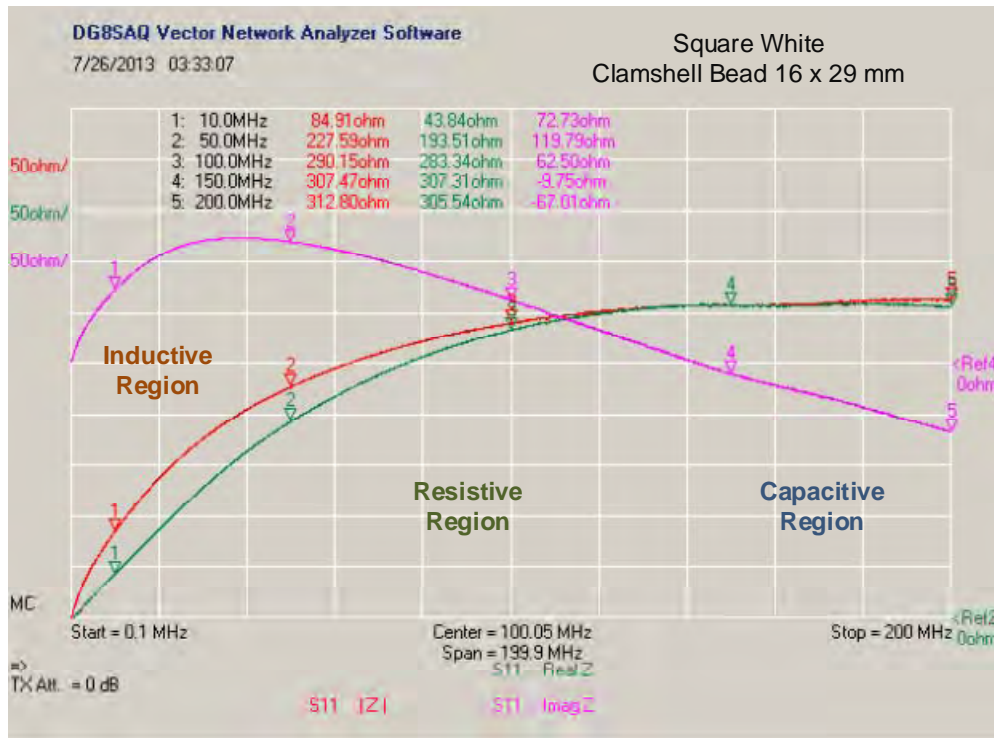


Figure 7 ~ Ferrite bead measurements indicate inductive, resistive and capacitive regions as frequency increases. Many beads show a linear increase in impedance at low frequencies, but this particular bead does not. These measurements were made on the test fixtures described later. Resonance is indicated where the impedance imaginary component is zero, just above 140 MHz for this bead. The colors corresponding to the traces are indicated at the bottom of the plot for impedance magnitude  $|Z|$ , RealZ (resistive component) and ImagZ (reactive component). The reference values for each trace are indicated on the right vertical scale and the ohms per division are on the left vertical scale. The markers tabulated at the top indicate the impedances at various frequencies.

A ferrite bead's effectiveness in suppressing noise currents depends on the relative magnitudes of the source, ferrite bead and load impedances at the frequencies of interest. These are shown in a further simplified equivalent circuit (figure 8). If the source and load impedances are known, the insertion loss in dB of a bead may be determined from

$$IL(dB) = 20 \cdot \log \left( \frac{Z_{source} + Z_{load}}{Z_{source} + Z_{load} + Z_{bead}} \right) \quad (1)$$

where  $Z_{source}$ ,  $Z_{load}$  and  $Z_{bead}$  are the respective impedances. It can be seen that, for given source and load impedances, increasing the bead impedance will increase the insertion loss. It is important to remember that the impedances are complex and must be known at the interfering noise frequencies.

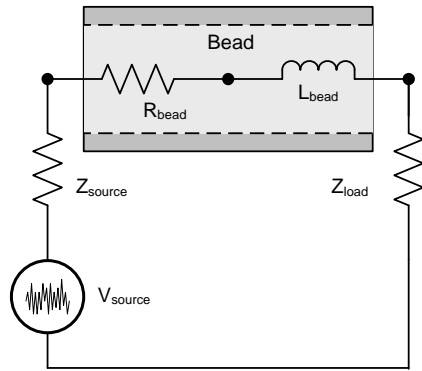


Figure 8 ~ Simplified equivalent circuit of a ferrite bead with the noise source (marked  $V_{source}$ ) and load. When the impedances are known, the insertion loss of the bead may be calculated. To be effective, the bead impedance at the noise frequencies must be much larger than the total source and load impedances.

Unfortunately, the source and load impedances usually are unknown and difficult to accurately measure at higher frequencies. There are two ways to approach this problem: 1) Figure out how to measure the source and load impedances and make the necessary calculations. An insertion loss of 3 to 6 dB would be a reasonable starting point although higher values may be necessary; or 2) Experiment with different cores, number of windings and number of cores, tempered by measurements described later, until the noise is reduced to an acceptable level. Approach 2) probably is the method undertaken by most readers of this article. A starting point is to strive for ferrite bead impedance on the order of 500 to 1000 ohms throughout the frequency range of interest. These loss and impedance values are somewhat arbitrary – the necessary values depend on the details of the noise environment – but it is often helpful to have a starting point.

#### I-4. Ferrite Bead Selection

Ferrite beads are readily available from electronic component distributors and sellers, surplus electronics sellers and auction websites. An internet search with keyword “ferrite bead” will reveal many companies. Some manufacturers allow factory-direct ordering. The cost of clamshell beads varies from about US\$0.50 to US\$10.00 each depending on the source. Some well-known manufacturers of ferrite beads are:

##### Manufacturers

Fair-Rite Products Corp.	<a href="http://www.fair-rite.com/newfair/index.htm">http://www.fair-rite.com/newfair/index.htm</a>
Ferrishield	<a href="http://www.ferrishield.com/">http://www.ferrishield.com/</a>
Ferroxcube	<a href="http://www.ferroxcube.com/">http://www.ferroxcube.com/</a>
Murata	<a href="http://www.murata.com/products/emc/index.html">http://www.murata.com/products/emc/index.html</a>
NEC/Tokin	<a href="http://www.nec-tokin.com/english/product/dl_emc.html">http://www.nec-tokin.com/english/product/dl_emc.html</a>
Parker Chomerics	<a href="http://www.chomerics.com/products/emi/cableconnector.html">http://www.chomerics.com/products/emi/cableconnector.html</a>
Laird (Steward)	<a href="http://www.lairdtech.com/Products/EMI-Solutions/Ferrite-Products/">http://www.lairdtech.com/Products/EMI-Solutions/Ferrite-Products/</a>
TDK	<a href="http://www.tdk.com/ferrites.php">http://www.tdk.com/ferrites.php</a>
Würth Elektronik	<a href="http://www.wel-online.com/web/en/passive_bauelemente_standard/willkommen_pbs/Welcome.php">http://www.wel-online.com/web/en/passive_bauelemente_standard/willkommen_pbs/Welcome.php</a>

Ferrite beads may be used in ordinary inductors at lower frequencies (in their linear impedance region) but for noise suppression applications the bead must be highly inductive or lossy at the noise frequencies, usually above 1 MHz. All clamshell beads are specifically designed for noise suppression. Unfortunately, most ferrite beads have no identification except possibly a color mark. This color is meaningless unless the user also knows the manufacturer and the color code. Some clamshell beads are marked with a manufacturer and part number on the shell; for example, TDK usually marks their clamshell beads. Almost all beads obtained from surplus electronics vendors and online auction websites have no identification. For unmarked

beads, it is necessary to perform some tests to determine their basic characteristics. Test fixtures are described in the next section.

One manufacturer, Fair-Rite, provides a chart that makes it relatively easy to select the proper bead from their product line (figure 9). In Part II we provide measurements for all Fair-Rite clamshell bead materials given in the chart. Some manufacturers claim to make parts that are equivalent to Fair-Rite, but it is impossible to verify equivalency without detailed tests or datasheets.

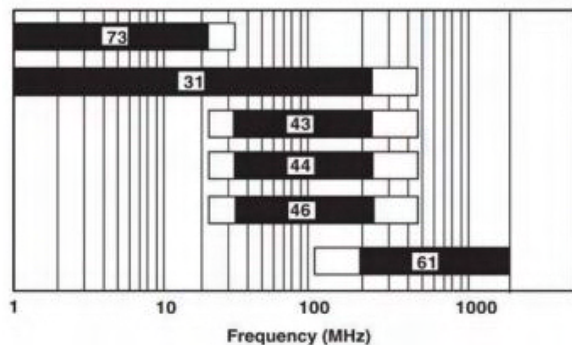


Figure 9 ~ Fair-Rite noise suppression materials. The categorization (73, 31, 43 and so on) is specific to Fair-Rite, although other manufacturers claim to make equivalent materials. According to this chart, for lower frequency noise suppression between 1 and 10 MHz, the 73 material would be a good choice and above 200 MHz, the 61 material would be a good choice. Illustration from fig. 26 of [Fair-Rite].

## I-5. Test Fixtures and Equipment

The preferred instrument for measuring ferrite bead impedance is an impedance analyzer that uses the *RF I-V* method. Another method, called *network analysis* or *reflection coefficient* method uses a vector network analyzer (VNA) (see references [HP], [Agilent1] and [Agilent2]). The RF I-V method is best because it measures applied voltage and induced current directly at the terminals of the device being measured. The VNA measures reflection coefficient (S11 scattering parameter) and converts the readings to complex impedances; however, as the measured impedance departs from the reference impedance (usually 50 ohms), the VNA measurement uncertainty increases. The rule-of-thumb best accuracy for inexpensive VNAs is when measurements fall in the 5 to 500 ohms range. The network/impedance analyzer with RF I-V fixture described below can have comparable accuracy over the 0.2 to 20k ohm range.

Our measurements were made with custom-built bead test fixtures and professional and semi-professional analyzers, the HP 4396A Network/Spectrum/Impedance Analyzer with a 43961A Impedance Test Kit (Hagen) and the DG8SAQ VNWA vector network analyzer (Reeve). The 4396A/43961A originally cost about US\$40000 (1995 catalog price) and the DG8SAQ VNWA about US\$700 (2013). The size and weight of the two test sets are roughly in the same ratio as costs. It is expected that the more expensive professional equipment provides higher measurement accuracy and lower uncertainty. We will discuss this in our results in Part II.

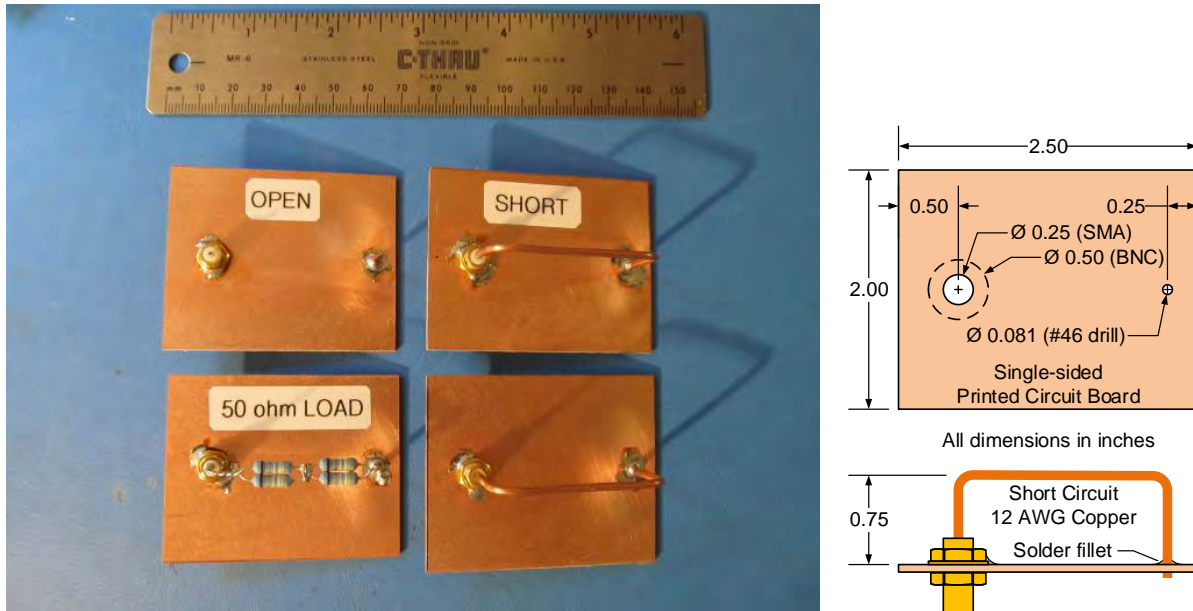


Figure 10 ~ Left: Test fixture calibrators for Short, Open and 50 ohm Load (two identical shorts are shown). The Short also holds the bead during measurement. Each fixture has a panel-mount SMA-F or BNC-F connector at one end (fixtures with SMA connectors are shown). Right: The dimensions shown are for the boards we built. The lower drawing shows the short circuit. The short circuit should be only long enough to hold the bead. The dimension shown will accommodate all but the largest clamshell beads.

The bead test fixtures were designed by one of us (Hagen) and were fabricated from sheets of single-sided copper printed circuit board (PCB) material. The fixtures use a connector that matches the analyzer – BNC connector for the HP 4396A/43961A impedance analyzer and SMA connector for the DG8SAQ VNWA. Three test boards are required for calibration and measurement, one each configured as a short circuit, open circuit and 50 ohm load (figure 10). These three serve as the Short, Open, Load (SOL) calibrators, and the Short fixture also is used to hold a bead during measurement. The shape and dimensions given are convenient for measuring a variety of clamshell beads. Solid beads also may be measured with this type of setup but require a little more work – the wire used for the short circuit and to hold the bead must be soldered and desoldered for each bead to be measured. We did not attempt to measure solid beads.



Figure 11 ~ Ferrite bead measurements.

Upper: The DG8SAQ VNWA (shown at lower-right) with the Short test fixture and a large clamshell bead (upper-left). The fixture is held in a work-holding vise. The VNWA was first calibrated with the extension cable and each of the Short, Open, Load fixtures. The red tag on the extension cable indicates its exclusive use with this particular VNWA.



Lower: The H-P 4396A VNA with 43961A Impedance Test Kit shown with the Short test fixture and a clamshell bead. The 43961A is first calibrated using HP SOL calibrated references directly at the APC-7 port. Then an APC-7 to BNC adapter is connected at the port and is compensated with each of the custom Short, Open, Load fixtures.

Ideally, the test fixture itself does not affect the measurements at the frequencies of interest (usually < 100 or 200 MHz). As a practical matter, this is difficult to achieve. For example, the Short and Load fixtures have measurable inductance and capacitance that is impossible to eliminate. The reactance effects are most noticeable in mid-VHF range and above. The Short should be made as small as possible, but it can be made only so small and still hold a bead. For the 50 ohm load we used ordinary resistors, four 49.9 ohm resistors in series-parallel (Reeve) and two 100 ohm resistors in parallel (Hagen), and this configuration undoubtedly has some inductive and capacitive reactance. As stated in the **Introduction**, the fixtures are adequate for our purposes (see next paragraph), which are to obtain reasonably good measurements comparable to manufacturer's data and to measure unidentified beads with unknown characteristics.

We each built our own SOL fixtures and calibrated the test sets as needed. We then placed a number of different clamshell beads on the Short fixture to measure their characteristics from 100 kHz to 200 MHz (figure 11). However, as we completed Part I of this article, we had not yet achieved an acceptable level of correlation between our measurements and recognize the calibration fixtures can be improved by, for example, reworking the connectors in the Open and Load fixtures and using surface mount device (SMD) load resistors to minimize reactance. We will describe these changes in Part II. Meanwhile, Reeve's initial measurements with the fixtures described here corresponded quite well with published results of Fair-Rite and other manufacturers to within  $\pm 20\%$ , but Hagen's reactance measurements especially did not correlate very well to Reeve's or Fair-Rite's. Hagen's initial measurements, in which the correlation was not as good as expected, were made by calibrating the HP impedance test fixture with the three PCB SOL fixtures as described above. He was able to improve the measurements by calibrating with a discrete Short, nothing connected to the impedance analyzer for the Open and a discrete 50 ohm Load instead of the PCB SOL fixtures. We continue working on this issue and hope to resolve it up before publication of Part II.

## I-6. Prior Work

The fixtures described above were inspired by a previous design one of us (Reeve) developed for testing multiple beads in series. This earlier design used a wood platform holding a 50 mm wide copper strip (figure 12). A section of coaxial cable was connected to each end of the strip and used to hold the beads. The fixture had a very sharp resonance at 100 MHz, which interfered with the bead measurements. It gave reasonable results below about 30 MHz but was wildly inaccurate at higher frequencies.

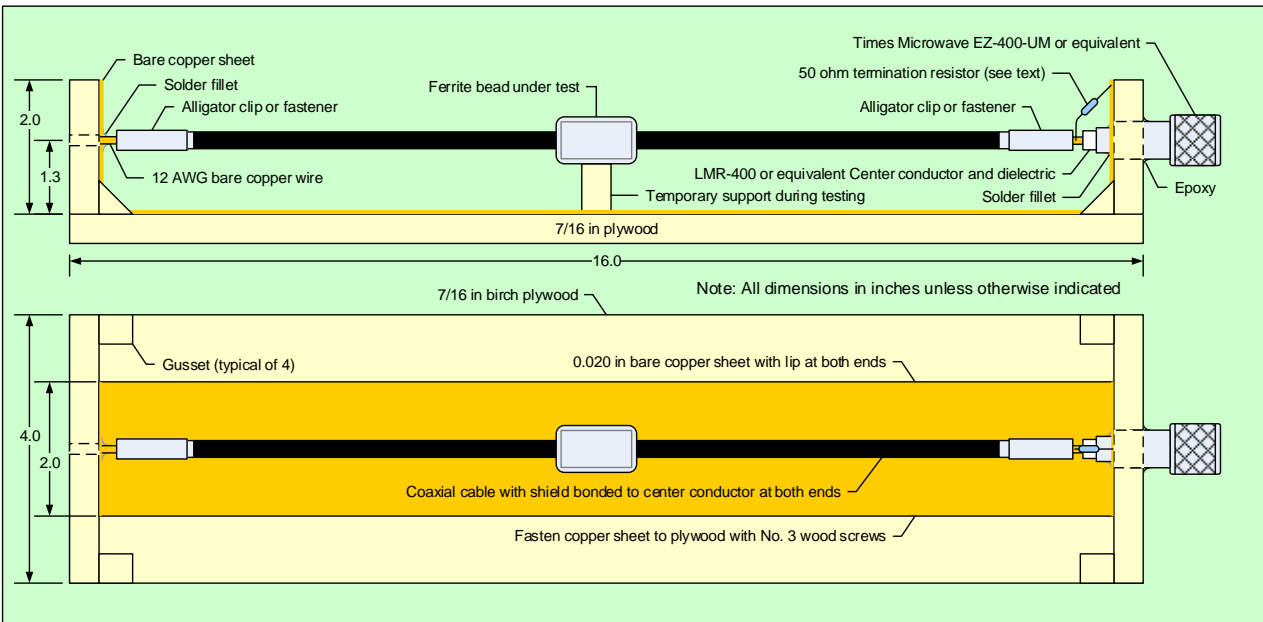


Figure 12 ~ Original ferrite bead test fixture. The fixture allowed at least five ferrite beads to be placed on the coaxial cable for testing. This fixture proved to be a failure for measuring ferrite beads above around 30 MHz.

## I-7. Conclusions

We discussed ferrites and their applications and described the test methods and fixtures that we use to measure ferrite bead impedance – the RF I-V method and reflection method. We each built three inexpensive printed circuit board test fixtures to provide Short, Open and Load for calibration and measurements. In Part II, we hope to resolve outstanding calibration issues and will provide comparative measurements of several clamshell beads using our fixtures and test equipment.

## I-8. References and Further Reading

### References:

- [Agilent1] Agilent Impedance Measurement Handbook, 4<sup>th</sup> ed., June 17, 2009
- [Agilent2] New Impedance Measurement Solutions and Applications using a Vector Network Analyzer, Agilent webcast, 2011:  
<http://www.home.agilent.com/agilent/eventDetail.jsp?cc=US&lc=eng&ckey=1968215&nid=-11143.0.00&id=1968215>
- [Fair-Rite] How to Choose Ferrite Components for EMI Suppression, Fair-Rite Products Corp. (date unknown)
- [HP] Amorese, G., RF Impedance Measurement Basics, Hewlett-Packard, 1998

### Transformer and inductor magnetics:

- Flanagan, W., Handbook of Transformer Applications, McGraw-Hill Book Co., 1986
- Kaiser, C., The Inductor Handbook, CJ Publishing, 1997
- Lowdon, E., Practical Transformer Design Handbook, Howard W. Sams & Co., Inc., 1985
- McLyman, W., Transformer and Inductor Design Handbook, Marcel Dekker, Inc., 2004
- Weir, S., Understanding Ferrite Beads and Applications, IPBLOX, LLC, 2009

Title: **Radio Nature**

Author: Renato Romero

Publisher: Radio Society of Great Britain (RSGB)

ISBN: 9781-9050-8637 5

Published: 2010 (original edition published in 2008)

Length: 220 pages, 25 chapters, no index

Status: In print

Availability: Available for US\$25 from ARRL (<http://www.arrl.org/shop/Radio-Nature/>) and 17 GBP from RSGB (<http://www.rsgbshop.org/>)

Reviewer: Whitham D. Reeve



In the preface of this paperback book the author warns “We’ve lost the direct physical contact with what surrounds us” and it “seems like scientific research by the individual belongs to the past or that it is possible only in hyper-technological environments.” He wrote this book to help the reader understand that these statements are wrong. His stated objective is to offer a “panoramic view” of naturally originating radio signals. The main focus is on how these phenomena can be observed, not how or why they occur. With twenty-five chapters in only 220 pages, a lot of ground is covered very quickly.

The naturally originating radio signals described in this book are limited to terrestrial electromagnetic phenomena with frequencies in and below the VLF band, around 100 kHz to as low as fractions of a hertz. Included are *spherics* (which he also calls *static*), *tweaks*, *the insects* (also called *buzzer*, and not the pesky crawling kind), *whistlers*, *auroral chorus*, *auroral hiss*, *flying saucers* (not the alien kind) and *seismic precursors*. Many of these are influenced or directly controlled by the Sun but some arise through terrestrial weather storms, earthquakes and other natural events.

Many of these phenomena occupy the band of frequencies that we could hear if we had an electric ear instead of a sonic ear. The sources of some are speculative and not widely agreed upon. The author’s explanations are similar to what one would find in credible science articles and books but sprinkled with what apparently are his own interpretations. I found them interesting and worth following up through online resources and other books.

Some natural radio emissions, such as whistlers, are produced by terrestrial lightning and propagated along Earth’s magnetic field lines. Whistlers produce eerie sounds in a receiver because the radio waves are dispersed as they travel great distances. Other natural radio emissions are related to the aurora. The auroral chorus usually is heard in the range of 400 to 1000 Hz. It can be detected with a large loop of wire connected to headphones or a PC sound card. It also is called the dawn chorus because it is most often heard in the

early morning hours. The chorus consists of a series of short rising tones that sound like a tree full of birds. In the evening, the auroral hiss is more likely to be heard. It ranges from about 2000 Hz to 100 kHz.

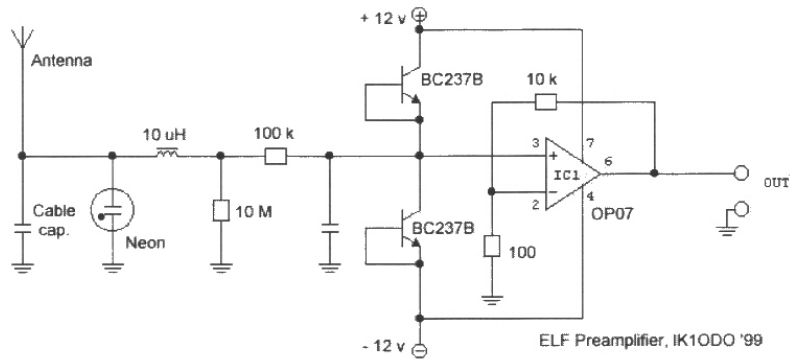
The author also describes what he calls “artificial signals”. These include hum and cyclic noises from electric power transmission and distribution systems, electric motors and, not to be forgotten, nuclear explosions. He classifies some as “false signals in the audio band” and others as “mysterious”. False signals include noise due to cross-modulation and receiver saturation, the “microphone effect” (commonly called *microphonics*, which are the transformations of mechanical vibrations into electrical noise – a phenomenon common in vacuum tubes), insects (the crawling kind), static discharge and wristwatches, among others.

The author says these false signals could be mistaken for radio nature. It should be noted that some man-made electrical noises described in this book are uniquely received in Europe, such as Alfa (or Alpha), a Russian navigation system, and certain low frequency (LF) and very low frequency (VLF) transmitting stations. These may or may not be observable in North America or other continents. The author defines mysterious signals as signals that sound natural but really are not. Many are received in areas of heavy industry. The author claims some are produced by extremely high power transmitting stations similar to the High Frequency Active Auroral Research Program (HAARP) in Alaska. I found the author’s explanations of some so-called mysterious signals speculative and dubious.

Some people like to argue that humans are not part of the natural environment, and by extension I suppose they also would argue that man-made radio signals are not part of nature. Nevertheless, it is convenient to separate man-made signals from all others. The author’s narrative of the sounds that result from detection of both natural and human signals is very descriptive: “fiiuuu”, “fiiuuuuuu”, “hissing”, biiiboooo sequence” and others that help us to recognize them. I seldom see this type of description, and it is one thing that sets this book apart from others – the information actually is useful and the reader is not left wondering what they received, if anything.

Many of nature’s electrical signals are at audio and sub-audio frequencies. Audio frequencies are in the range of around 20 Hz to 20 kHz – the range depends on who you talk to. It should be clear by now that the signals of interest are electrical and not sound and, therefore, we cannot hear them directly. If we wish to listen to these signals, we must first convert them from electrical to sound. Signals of interest usually will be fed from a detector or amplifier to a PC soundcard for spectrum analysis and processing. The soundcard and associated speaker convert the signals in the audio band from electrical to sound. However, signals below the audio band must be speeded up by software processing in the PC, in which case we listen to an adaption of the original signals to the human ear.





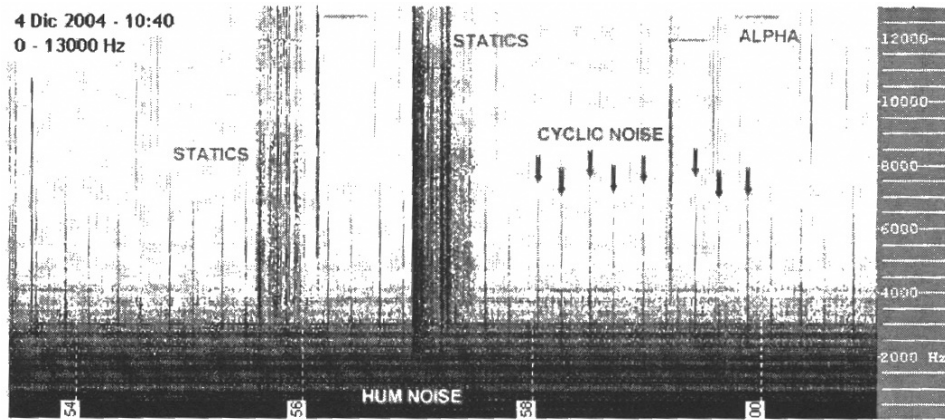
This circuit of a simple ELF receiver is able to accept the signal from a small whip, but also able to tolerate very long wire antennas without distortion (Marco Bruno's project, IK1ODO).

In some ways **Radio Nature** is like a few other books that cover radio waves at low frequencies or extremely long wavelengths but it provides much more detail. The author includes descriptions and schematics for monitors that can be used to capture radio nature, audio recording methods, analysis software, and advice on unattended operation and coordinated listening. All of these are tools that most amateur radio astronomers already use, so in many ways they have half the problem of receiving and recording radio nature already solved.

The schematics (example above, from page 127) and descriptive information are sufficient for anyone with electronics experience to build suitable equipment from readily available components. Most of the circuits have been around for a while and an internet search will reveal numerous versions of the same schematic. In some cases, a search will reveal improvements but in other cases just the opposite. With this book, however, readers have access to the circuits and antenna designs in one place. It should be noted that most of the schematics and construction details are, for the most part, nothing special – simple amplifiers and filters made from operational amplifier (opamp) integrated circuits and loop antennas or whip antennas – but with made-up names that try to indicate a special design (which they are not).

The author refers to some apparently established designs by their model number, and in several cases I could not find any useful information about them. Also, some technical explanations seemed over-simplified and have significant doses of hand-waving, and I would advise the reader to attempt to independently verify them. Of course, the proof is in the results; that is, if the circuit or antenna works as intended then the seemingly flawed explanations can be overlooked for the time being.

**Radio Nature** explains spectrum analysis from an applications point-of-view. It has a chapter on “managing FFT parameters”, which uses a little algebra but at least it is not mathematically opaque. The author also describes software filtering, including HUMID (Hum Instant Destroyer), and radio localization (or radio direction finding, RDF). The book includes many spectrogram images that have been annotated to help readers understand them. The only drawback is that the images are in black-and-white and, thus, the color intensity information has been converted to a gray scale making them somewhat difficult to interpret (for example, see the spectrogram below from page 46).



Unfortunately, **Radio Nature** proves once again that book publishers no longer employ editors. The book contains many typographical errors and grammatical mistakes. These are relatively minor annoyances for readers with the motivation to study the material but will be frustrating to people who enjoy reading correctly formed sentences.

In summary, **Radio Nature** has considerable useful information backed up by the author's experience. It is for motivated readers who want to detect natural electromagnetic signals from VLF down to sub-audio and are willing to experiment with a suitable detector, soundcard and PC running spectrum analysis software with recorder capability. To be successful, the detector setup should be a way from man-made electromagnetic interference, and this almost always means rural locations some distance from electric powerlines.



**Reviewer** - Whitham Reeve has lived in Anchorage, Alaska his entire life. He worked as an engineer and engineering firm owner/operator in the airline and telecommunications industries for more than 40 years and is now a director of SARA and contributing editor for the SARA journal.



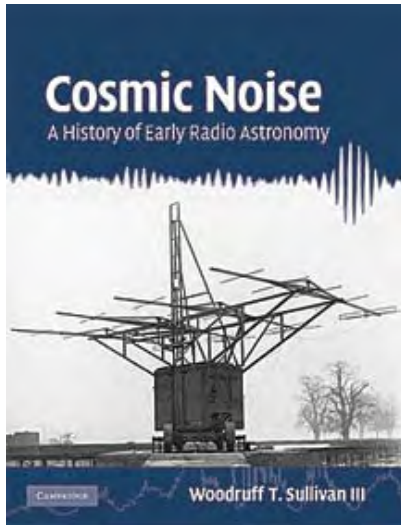
## Book Review- *Cosmic Noise* by Sullivan

Reviewer: Dave James

Ahead of the Contents section of his monumental tome Sullivan includes this lovely quotation that sets the scene exquisitely:

“I had the opportunity only yesterday of watching Sagittarius rise in broad daylight on the needle of a millivoltmeter ..... It is certainly gratifying to see gunlaying radar apparatus put to such uses!”

- Alan Hunter, Royal Greenwich Obs., 1946



**Cosmic Noise: A History of Early Radio Astronomy** by W. T. Sullivan, Cambridge Univ. Press, 2009; 574 pp., \$140 US  
ISBN: 9780521765244

“Woody” Sullivan is a professor of both astronomy and history at the University of Washington, Seattle and this comprehensive account of the early years of radio astronomy took him - part time and finally full time for 2006 - over 35 years to complete, much longer than the historical range of developments chronicled. This is a work of great scholarship, with full annotations and referencing and also taking into account interviews around the world, many of multiple long sessions, with over 115 early workers in this field, lab. note books, contemporary correspondence and personal photographs. The author’s long preparation has been a labour of love, and it shows. This book is of fairly large format, modest font size, and is extremely well presented and profusely illustrated, albeit not in colour. The only

negative thing I can point out is that it is a tad expensive, but nevertheless it’s really great value (I managed earlier this year to buy an imperceptibly ‘damaged’ copy at about 70% of the list price.).

There are 18 chapters as well as appendices containing more information on the interviews; listings of bibliographies, biographies and archive material sources, radar development literature; and most significantly a 20 pp. appendix which supplies a superb primer on the “techniques and astrophysics of early radio astronomy”, especially on phase switching and interferometry. Here is a partial listing of chapter headings and some selected sub-headers to convey some feel for scope and depth of this erudite book:

Searching for solar Hertzian waves	Hertz, Edison & Kenelly, Lodge, Wilsing & Schneider, Nordmann, why no-one discovered solar radio waves until 4 decades after Nordmann?
Jansky and his star static	early years, the setting for Jansky’s work, investigations, later years, reaction of the scientific community, was Jansky ‘stopped’ by Friis?, why did Jansky succeed?
Grote Reber: science in your backyard	the man and his dish, etc.
Wartime discoveries of the radio sun	radar development, Hey, other wartime sun incidents, pre-war observations, Appleton controversy, Southworth and the quiet sun
Hey’s group post-war	
Radiophysics Lab, Sydney	
Ryle’s group at the Cavendish	
Lovell at Jodrell	
Meteor radar	
Reaching for the moon	
Theories of galactic noise	
The 21 cm hydrogen line	

Most chapters are around 25 pp. or so each. Basically the coverage is up to 1953, although there is plenty of mention of later developments to set matters in context.

I have read many accounts of my personal hero, Grote Reber, but that here is the most comprehensive, detailed and rounded that I have yet encountered. It is also delightfully easy to read, and overall these comments seem to apply to any chapter one picks. Indeed I discovered that one can dip into it on almost any page and pick up the thread and become completely engrossed.

There is good insight into the personal and social lives of the earlier workers; the problems with funding and military obsessions, especially as the Cold War started; the (rather gentlemanly) professional rivalries in a few places; and how the 'community', such as it was, had great difficulty gaining the respect of the traditional optical astronomers ('astronomers', in fact). Sullivan chronicles the awful discrimination encountered by the only woman in the immediate post-war years to make a substantial contribution, Ruby Payne-Scott (at CSIRO). There are some fine orthogonal cuts taken through this large subject area, too. As one example, there are separate sections on the various national teams around the globe that made significant and indeed lesser contributions, with plenty of detail into their different styles, their political and other problems, their strengths and weaknesses – all this in digestible form and quite separate from the general chronological thread of most of the book. So one sees the developmental paths from different angles and vicariously through differing cultural assumptions.

There are some wonderful photos of early gear, and lab. book page copies to convey an immediacy to the narrative. One significant photo record shows an early oscilloscope CRT display with a stop watch in the right hand corner to supply the time stamping! It's also sobering - and sadly amusing - to be reminded of the real shortage of funds that were the stuff of everyday frustrations by luminaries such as Lovell and Ryle (difficulty justifying a subscription to *Nature*, a crucial journal for RA at that time, and the shenanigans in securing chart recorder paper from the USA for the Cavendish and Jodrell teams). It is also good to see the few women who could contribute in these early years properly recognised here, including the UK radio amateur Nelly Corry and Jodrell's Mary Almond.

Do not think for one moment that this is a dry, convoluted and mind-numbing account. Certainly Sullivan well conveys the confusion and false trails, the practical technological problems that would trouble these early workers, but it's done in a masterful, digestible style. As it happens, my late father was a navigator/bomb-aimer during WWII, and used kit that Ryle, Lovell and others developed so frenetically in so few years, so I was especially interested in this vignette, which also serves to give a flavour of this book:

"Before better equipment could be built, however, Ryle and Vonberg devoted much of their first year to restocking the bare shelves of the Cavendish with everything from voltmeters and cable to giant antennas. This could not be done with purchases, as there was no money, so they took advantage of the plethora of war surplus electronics available for a song. They were of course familiar with the British equipment, but Ryle also knew which *German* equipment was desirable. Moreover a German item was easier to acquire because it didn't have a serial number on it that needed processing by a bureaucrat. ....; in fact during the war he [Ryle] could even tell whether an unknown transmitter was British or German because the Germans' frequency stability was markedly superior.

Five truckloads of surplus gear were looted from a depot at the Royal Aircraft Establishment (RAE) at Farnborough. The most spectacular finds were several 3m and 7.5m diameter Würzburg dishes, which later played an important part in solar and radio source measurements. As Ryle later recalled:

"We went to RAE to arrange for the transport of the Würzburgs, but found they'd unfortunately just been sold to a scrap metal merchant, which was sad. But we drove around to see the merchant and he was a very nice chap. When I told him we wanted them for scientific research, he said, "You can have them! I like science". We swapped them for some other stuff and we all parted happily. But then we were in a bit of a fix because gifts to the University of Cambridge have to be recited in the Senate House in Latin and we weren't quite sure how we'd translate all this stuff about German radar sets!"

After six years of trying to outwit and defeat German engineering, Ryle could now profit from it"

It is sobering to think how life has changed since those times, and how the radio spectrum has filled so greatly. I was intrigued to notice, for example, that the picture on the front cover (see figure above) is that of one of the antennas used by Hey's group and which helped lead to the discovery of the discrete radio star *Cygnus A*. But where was it sited? In Richmond Park, London! (If you don't know London well, this public park has an area about the size of the Bois de Boulogne in Paris or some three times that of New York's Central Park).

For me, this is the definitive book to chronicle the early days of radio astronomy, in all its facets. One can gain some greater insight into radio astronomy and geophysics, too, unless you are already an astronomy professional. This is scholarship of the highest order. Beg, borrow or steal a copy - but not mine!

-----



**Reviewer:** Dave James lives in the S West of England, and most of his working life was in R&D in microwave technology. This covered components thru systems for spacecraft, radar, EW, telecoms., missiles, avionics, satcom, cellular radio and at times included building paramp and other front-ends for radio astronomers. He worked in Canada for some years and has also been a consultant, founded a company specialising in solid-state microwave amplifiers, and has worked in spectrum regulatory and standards development for cellular systems. Now retired, he recently became a radio ham and amateur radio astronomer, and he's also developing a honey bee traffic monitor.

## Understanding Engineers

An engineer was crossing a road one day, when a frog called out to him and said, "If you kiss me, I'll turn into a beautiful princess." He bent over, picked up the frog, and put it in his pocket. The frog spoke up again and said, "If you kiss me, I'll turn back into a beautiful princess and stay with you for one week." The engineer took the frog out of his pocket, smiled at it and returned it to the pocket. The frog then cried out, "If you kiss me and turn me back into a princess, I'll stay with you for one week and do anything you want." Again, the engineer took the frog out, smiled at it and put it back into his pocket.

Finally, the frog asked, "What is the matter? I've told you I'm a beautiful princess and that I'll stay with you for one week and do anything you want. Why won't you kiss me?" The engineer said, "Look, I'm an engineer. I don't have time for a girlfriend, but a talking frog - now that's cool."



## Great Projects to Get Started in Radio Astronomy



The **Radio Jove Project** monitors the storms of Jupiter, solar activity and the galactic background. The radio telescope can be purchased as a kit or you can order it assembled. They have a terrific user group you can join. <http://radiojove.gsfc.nasa.gov/>



The **INSPIRE program** uses build-it-yourself radio telescope kits to measure and record VLF emissions such as tweeks, whistlers, sferics, and chorus along with man-made emissions. This is a very portable unit that can be easily transported to remote sites for observations.

<http://theinspireproject.org/default.asp?contentID=27>

### Sky Scan Awareness Project

When a meteor passes through the Earth's atmosphere, it ionizes the atmosphere which improves its ability to reflect radio waves. This allows you to briefly hear a far away radio station that you normally couldn't detect. In this project, you can install an antenna, use an FM radio receiver, computer software, and learn to observe meteor showers using this very simple radio telescope. For more information about this project, please visit [FM Radio Meteor Project](#).



### SARA/Stanford SuperSID



Stanford Solar Center and the Society of Amateur Radio Astronomers have teamed up to produce and distribute the SuperSID (Sudden Ionospheric Disturbance) monitor. The monitor utilizes a simple pre-amp to magnify the VLF radio signals which are then fed into a high definition sound card. This design allows the user to monitor and record multiple frequencies simultaneously. The unit uses a compact 1 meter loop antenna that can be used indoors or outside. This is an ideal project for the radio astronomer that has limited space. To request a unit, send an e-mail to [supersid\\_at\\_radio-astronomy\\_dot\\_org](mailto:supersid_at_radio-astronomy_dot_org).

# Membership

## New Members –

Please welcome our new SARA members who have joined since the last journal. If your name is missing or misspelled, please send an email to [treasurer@radio-astronomy.org](mailto:treasurer@radio-astronomy.org). We will make sure it appears correctly in the next Journal issue. As of June 21, 2013:

First Name	Last Name	City	State/Province	Country	Ham ID
Robert	Arrowsmith	Blackburn South	Victoria	Australia	VK3XRA
Bill	Bogardus	Greenport	NY	USA	
Ben	Child	Yorktown Heights	NY	USA	
Zachary	Frantsen	Springfield	MO	USA	
Tobin	Fricke	Hannover		Germany	KE6WHF
Steven	Goldberg	Boonsboro	MD	USA	W3SFG
Bill	Gromen	Spring Grove	PA	USA	
Wolfgang	Herrman	Sankt Augustin		Germany	
Michael	Lowe	Colorado Springs	CO	USA	
H Shane	Mills	Parkersville	WV	USA	
Chris	Pegrum	Tunbridge Wells	Kent	UK	
Jonathan	Rawlinson	Sandhurst	Kent	UK	MOZJO
Liu	Shanqian	Guangzhou	Guangdong Province	China	
Robert	Smith	Pontiac	IL	USA	
Dirk	Van Hessche	Appelterre		Belgium	

## SARA Membership Dues and Promotions –

Membership dues are \$20.00 US per year and all dues expire in June. Student memberships are \$5.00 US per year. Members joining from June to December of 2013 will renew their membership June 2014. Members joining January to June 2014 will renew June 2015. Or pay once and never worry about missing your dues again with the SARA Life Membership. SARA Life Memberships are now offered for a one-time payment of twenty times the basic annual membership fee (currently \$400 US).

## Journal Archives & Other CDs Promotion

The entire set of The Journal of The Society of Amateur Radio Astronomers is available on CD. It goes from the beginning of 1981 to the end of 2012 (over 4000 pages of SARA history!) Or you can choose one of the following CD's or DVD:\* (Prices are US dollars and include postage.)

- SARA Journals from 1981 through 2012
- SARA Mentor CD, compiled by Jim Brown
- SARA Navigator (IBT) CD and DVD, compiled by Jon Wallace

Prices, US dollars, including postage

Members	Each disk	\$15.00
	Disk + 1 year membership extension	\$30.00
Non-members	Each disk	\$25.00
	Disk + 1 year membership	\$30.00
Non-USA members	Each disk	\$20.00 (airmail)
	Disk + 1 year members extension	\$35.00

\*Already a member and want any or all of these CD's or DVD's? Buy any one for \$15.00 or get any three for \$35.00.

**SARA Store** (<http://www.radio-astronomy.org/store>)

SARA offers the above CDs, DVDs, printed Proceedings and Proceedings on CD and other items at the SARA Store: <http://www.radio-astronomy.org/e-store>. Proceeds from sales go to support the student grant program. Members receive an additional 10% discount on orders over \$50 US. Payments can be made by sending payment by PayPal to [treasurer@radio-astronomy.org](mailto:treasurer@radio-astronomy.org) or by mailing a check or money order to SARA, c/o Melinda Lord, 2189 Redwood Ave, Washington, IA 52353

## SARA Online Discussion Group

SARA members participate in the online forum at <http://groups.google.com/group/sara-list>. This is an invaluable resource for any amateur radio astronomer.

## SARA Conferences

SARA organizes multiple conferences each year. Participants give talks, share ideas, attend seminars, and get hands-on experience. For more information, visit <http://www.radio-astronomy.org/meetings>.

## Facebook

Like SARA on Facebook <http://www.facebook.com/pages/Society-of-Amateur-Radio-Astronomers/128085007262843>

## Twitter

Follow SARA on Twitter [#radio astronomy1](https://twitter.com/radioastronomy1)



## Administrative

The Society of Amateur Radio Astronomers is an all-volunteer organization. The best way to reach people on this page is by email with SARA in the subject line.

### SARA Officers

**President:** William Lord, [president@radio-astronomy.org](mailto:president@radio-astronomy.org), +1 319-591-1131

**Vice President:** Tom Crowley, [vicepres@radio-astronomy.org](mailto:vicepres@radio-astronomy.org), +1 404-375-5578

**Secretary:** Tom Hagen, [secretary@radio-astronomy.org](mailto:secretary@radio-astronomy.org), +1 248-650-8951

**Treasurer:** Melinda Lord, [treasurer@radio-astronomy.org](mailto:treasurer@radio-astronomy.org), +1 319-591-1130

**Founder & Director Emeritus:** Jeffrey M. Lichtman, [Jeff@RadioAstroSupplies.com](mailto:Jeff@RadioAstroSupplies.com), +1 954-554-3739

**Past President:** William Lord, [president@radio-astronomy.org](mailto:president@radio-astronomy.org), +1 319-591-1131

### Board of Directors

Name	Term expires	Email
Ken Redcap	2015	<a href="mailto:pacder@hotmail.com">pacder@hotmail.com</a>
Chip Sufitchi	2015	<a href="mailto:ciprian@sufitchi.com">ciprian@sufitchi.com</a>
Chuck Forster	2014	<a href="mailto:cforster@phasorlabs.com">cforster@phasorlabs.com</a>
Charles Osborne	2014	<a href="mailto:k4cso@charter.net">k4cso@charter.net</a>
Whitham D. Reeve	2014	<a href="mailto:whitreeve@gmail.com">whitreeve@gmail.com</a>
Curt Kinghorn	2015	<a href="mailto:curtkinghorn@gmail.com">curtkinghorn@gmail.com</a>
Dave Typinski	2014	<a href="mailto:davetyp@typnet.net">davetyp@typnet.net</a>
Stan Nelson	2015	<a href="mailto:stannelson@cableone.net">stannelson@cableone.net</a>

### Other SARA Contacts

All Officers	----	<a href="mailto:officers@radio-astronomy.org">officers@radio-astronomy.org</a>
All SARAJ Editors	----	<a href="mailto:editor@radio-astronomy.org">editor@radio-astronomy.org</a>
Annual Meeting	Vice President	<a href="mailto:vicepres@radio-astronomy.org">vicepres@radio-astronomy.org</a>
All <i>Radio Astronomy</i> Editors	---	<a href="mailto:editor@radio-astronomy.org">editor@radio-astronomy.org</a>
Radio Astronomy Editor	Melinda Lord	<a href="mailto:Ap_guardian@yahoo.com">Ap_guardian@yahoo.com</a>
Radio Astronomy Contributing Editor	Christian Monstein	<a href="mailto:monstein@astro.phys.ethz.ch">monstein@astro.phys.ethz.ch</a>
Radio Astronomy Contributing Editor	Whitham D. Reeve	<a href="mailto:whitreeve@gmail.com">whitreeve@gmail.com</a>
Radio Astronomy Contributing Editor	Stan Nelson	<a href="mailto:stannelson@cableone.net">stannelson@cableone.net</a>
Educational Outreach	David Fields	<a href="mailto:education@radio-astronomy.org">education@radio-astronomy.org</a>
Grant Chair		
International Ambassador	----	----
Librarian	Cliff Bates	<a href="mailto:cliff@smwireless.net">cliff@smwireless.net</a>
Membership Chair	Tom Crowley	<a href="mailto:membership@radio-astronomy.org">membership@radio-astronomy.org</a>
Mentor Program	Jon F. Wallace	<a href="mailto:mentor@radio-astronomy.org">mentor@radio-astronomy.org</a>
Navigators	Tom Crowley	<a href="mailto:tomcrowley@mindspring.com">tomcrowley@mindspring.com</a>
Technical Queries	Jon F. Wallace	<a href="mailto:technical@radio-astronomy.org">technical@radio-astronomy.org</a>
Webmaster	Ciprian (Chip) Sufitchi	<a href="mailto:webmaster@radio-astronomy.org">webmaster@radio-astronomy.org</a>

## Resources

European Space Agency's (ESA) Planck spacecraft was launched in 2009 to survey the entire sky at microwave and submillimeter wavelengths. So far 28 papers have been released on the results, and the first one is:

*Planck 2013 Results. I. Overview of Products and Scientific Results:* <http://arxiv.org/abs/1303.5062>

To read each of the 28 papers, enter the address: <http://arxiv.org/abs/1303.50xx>, where xx = 62 ... 90

Digital Radio Astronomy, Building a Radio Telescope using an SDR receiver:

<http://radioadastra.blogspot.com/>

JSTOR, the not-for-profit digital library of thousands of academic journals and other content has more than one million articles accessible by individuals participating in its free program, Register & Read:

<http://about.jstor.org/rr>

USB soundcard with 192 kHz sampling rate for software defined radio applications, claimed to be suitable ELF, SLF, ULF, VLF and lower LF spectrum analysis. See for yourself:

[http://ecom.eladit.com/WebRoot/ce\\_it/Shops/990298944/MediaGallery/ELF-19\\_Leaflet\\_1\\_ING\\_LO.pdf](http://ecom.eladit.com/WebRoot/ce_it/Shops/990298944/MediaGallery/ELF-19_Leaflet_1_ING_LO.pdf)

Radio astronomy articles and supplier of total power radiometer for 10 to 12 GHz, RadioAstroLab in Italy:

<http://www.radioastrolab.it/en>

Radio astronomy supplier in Sweden:

<http://poamelectronics.com/index.html>

"Ultimate HF antenna" (or so the manufacturer claims):

<http://www.alphacognetics.com/index.htm>. Read about it here:

<http://urgentcomm.com/antennas/here-s-perfect-antenna>

Impact of Ultralow Phase Noise Oscillators on System Performance:

<http://www.crystek.com/documents/appnotes/ImpactUltralow.pdf>

Demystifying Integrated-Phase-Deviation Results in Phase-Noise Measurements: <http://mwr.com/test-amp-measurement-analyzers/demystify-integrated-phase-deviation-results-phase-noise-measurements>

Get a Handle on Oscillator Phase Noise and Jitter: <http://mwr.com/active-components/get-handle-oscillator-phase-noise-and-jitter>

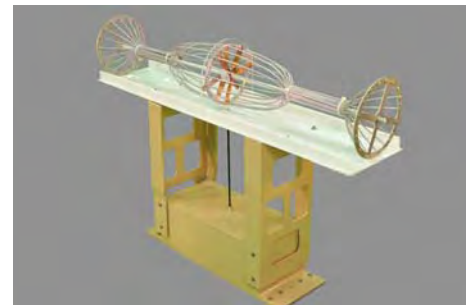
Description of RF splitter/combiner (also called Wilkinson splitter): <http://www.radio-electronics.com/info/rf-technology-design/coupler-combiner-splitter/wilkinson-splitter-combiner-divider.php>

Electronic Design magazine, free white papers: <http://electronicdesign.com/white-papers>

Online course *Fundamentals of Printed Circuit Board Design*: <http://techonline.com/electrical-engineers/education-training/courses/4000356/Fundamentals-of-PCB-Design>

Electrostatic discharge (ESD) can ruin your precious electronics. View a tutorial here: <http://www.radio-electronics.com/info/circuits/esd/what-is-basics-electrostatic-discharge-tutorial.php>

Here is a question from American Institute of Physics: *A neutron is negatively charged, True or False?* If you cannot answer this question and even if you can, you will find this website devoted to addressing the science gap: <http://www.insidescience.org/>



## Online Resources

### British Astronomical Association – Radio Astronomy Group

<http://www.britastro.org/baa/>

### CALLISTO Receiver & e-CALLISTO

<http://www.reeve.com/Solar/e-CALLISTO/e-callisto.htm>

CALLISTO data archive: <http://e-callisto.org>

### Deep Space Exploration Society

<http://dses.org/index.shtml>

### European Radio Astronomy Club

<http://www.eraonet.org>

### GNU Radio

<http://www.gnu.org/licenses/gpl.html>

### Inspire Project

<http://theinspireproject.org>

### NASA Radio JOVE Project

<http://radiojove.gsfc.nasa.gov>

### Archive:

<http://jovearchive.gsfc.nasa.gov>

### National Radio Astronomy Observatory

<http://www.nrao.edu>

### NRAO Essential Radio Astronomy Course

<http://www.cv.nrao.edu/course/astr534/ERA.shtml>

### Pisgah Astronomical Research Institute

<http://www.pari.edu>

### SARA Web Site

<http://radio-astronomy.org>

### SARA Email Forum and Discussion Group

<http://groups.google.com/group/sara-list>

### Radio Astronomy Supplies

<http://www.radioastronomysupplies.com>

### Radio Sky Publishing

<http://www.radiosky.com>

### RF Associates

Richard Flagg, [rf@hawaii.rr.com](mailto:rf@hawaii.rr.com)

1721-I Young Street, Honolulu, HI 96826

### RFSpace, Inc.

<http://www.rfspace.com>

### Shirleys Bay Radio Astronomy Consortium

[marcus@propulsionpolymers.com](mailto:marcus@propulsionpolymers.com)

### Simple Aurora Monitor Magnetometer

<http://www.reeve.com/SAMDescription.htm>

### SETI League

<http://www.setileague.org>

### SkyScan Science Awareness (Meteor Detection)

[http://www.skyscan.ca/getting\\_started.htm](http://www.skyscan.ca/getting_started.htm)

### Stanford Solar Center

<http://solar-center.stanford.edu/SID/>

### UK Radio Astronomy Association

<http://www.ukraa.com/www/>

### SARA Facebook page

<https://www.facebook.com/pages/Society-of-Amateur-Radio-Astronomers/128085007262843>

### SARA Twitter feed

<https://twitter.com/RadioAstronomy1>

## SARA Polo Shirts for Sale

SARA has polo shirts with the new SARA logo embroidered. (No pocket) These are 50% cotton and 50% polyester, machine washable. Currently in stock:



Size	Color
Small	Navy
Large	Maroon, Black, Navy
X-Large	Maroon, Black, Navy
XX-Large	Maroon, Black, Navy, Dark Green
XXX-Large	Black, Navy, Dark Green

Price is \$15 with free shipping in the USA. Additional cost for shipping outside the USA. Other colors and sizes available, contact SARA Treasurer, Melinda Lord, at [treasurer@radio-astronomy.org](mailto:treasurer@radio-astronomy.org).

## For Sale, Trade, and Wanted

There is no charge to place an ad in *Radio Astronomy*; but, you must be a current SARA member. Ads must be pertinent to radio astronomy and are subject to the editor's approval and alteration for brevity. Please send your "For Sale," "Trade," or "Wanted" ads to [editor@radio-astronomy.org](mailto:editor@radio-astronomy.org). Please include email and/or telephone contact information. Please keep your ad text to a reasonable length. Ads run for one bimonthly issue unless you request otherwise.

### For sale

RFSpace SDR-14, S/N KI001026, new in box, asking \$975

Price negotiable, includes postage. Contact Dave Typinski, [davetyp@typnet.net](mailto:davetyp@typnet.net)

### For sale

Items listed below. Send request to SARA by email to [supersid@radio-astronomy.org](mailto:supersid@radio-astronomy.org).

For more information: <http://www.radio-astronomy.org/pdf/sid-brochure.pdf> .

Description, items for sale by SARA	Price (US\$)
SuperSID VLF receiver (assembled)	\$48.00
PCI soundcard, 96 kHz sample rate	\$40.00
Antenna wire 24 AWG (120 m)	\$23.00
Coaxial cable, Belden RG58U (9 m)	\$14.00
Shipping (United States)	\$10.00
Shipping (Canada, Mexico)	\$25.00
Shipping (all other)	\$40.00

### For sale

Description, items for sale by SARA	Price (US\$)
New-in-box twist-on male TNC Connector for RG-58 cable, 23 available	\$1.00/each
New Berk-Tek twist-on male TNC Connector for RG-59 cable, 10 available	\$1.00/each
New twist-on male BNC connector 1-Piece 50 ohm for RG-6 cable, 21 available	\$1.00/each
Belden RG58U Coax <u>25 CENTS per foot</u> , odd lengths from 13' to 19'	

All are plus shipping. Will consider offers. Items are surplus and all proceeds go to support the SARA/Stanford SuperSID project. Contact Bill Lord (319)591-1131 or email [supersid@radio-astronomy.org](mailto:supersid@radio-astronomy.org)